

**MITCHELL & BROWN**

**OPERATING INSTRUCTIONS**

**JB-24DVD1811**

**COLOUR TELEVISION**

## Contents

Environmental Information.....	3
Standby Notifications.....	4
TV Control Switch & Operation.....	4
Using Main TV Menu .....	5
Inserting the Batteries into the Remote .....	5
Power Connection .....	5
Antenna Connection .....	5
Disposal Information.....	6
Remote Control .....	7
Connections.....	8
Switching On/Off.....	9
First Time Installation.....	9
Media Playback via USB Input .....	9
Media Browser.....	10
CEC .....	10
Settings Menu Contents .....	11
Using the Channel List .....	15
Configuring Parental Settings.....	15
Electronic Programme Guide .....	15
Teletext Services (where available).....	16
Troubleshooting & Tips .....	16
AV and HDMI Signal Compatibility .....	17
Supported File Formats for USB Mode .....	18
Supported DVI Resolutions .....	19
Wired Network Connection.....	20
DVB functionality information .....	20
DVD Mode .....	21
Important Instructions.....	26

## Safety Information

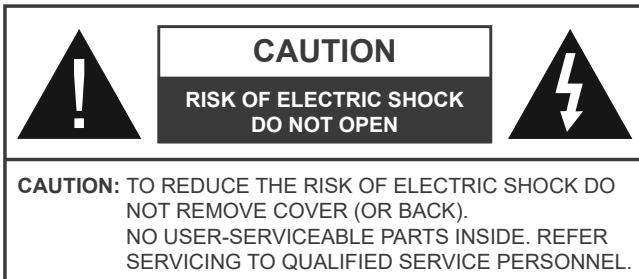

In extreme weather (storms, lightning) and long inactivity periods (going on holiday) disconnect the TV set from the mains.

The mains plug is used to disconnect TV set from the mains and therefore it must remain readily operable. If the TV set is not disconnected electrically from the mains, the device will still draw power for all situations even if the TV is in standby mode or switched off.

**Note:** Follow the on screen instructions for operating the related features.

### IMPORTANT - Please read these instructions fully before installing or operating

**WARNING:** This device is intended to be used by persons (including children) who are capable / experienced of operating such a device unsupervised, unless they have been given supervision or instruction concerning the use of the device by a person responsible for their safety.

- Use this TV set at an altitude of less than 2000 meters above the sea level, in dry locations and in regions with moderate or tropical climates.
- The TV set is intended for household and similar general use but may also be used in public places.
- For ventilation purposes, leave at least 5cm of free space around the TV.
- The ventilation should not be impeded by covering or blocking the ventilation openings with items, such as newspapers, table-cloths, curtains, etc.
- The power cord plug should be easily accessible. Do not place the TV, furniture, etc. on the power cord. A damaged power cord/plug can cause fire or give you an electric shock. Handle the power cord by the plug, do not unplug the TV by pulling the power cord. Never touch the power cord/plug with wet hands as this could cause a short circuit or electric shock. Never make a knot in the power cord or tie it with other cords. When damaged it must be replaced, this should only be done by qualified personnel.
- Do not expose the TV to dripping or splashing of liquids and do not place objects filled with liquids, such as vases, cups, etc. on or over the TV (e.g., on shelves above the unit).
- Do not expose the TV to direct sunlight or do not place open flames such as lit candles on the top of or near the TV.

- Do not place any heat sources such as electric heaters, radiators, etc. near the TV set.
- Do not place the TV on the floor and inclined surfaces.
- To avoid danger of suffocation, keep plastic bags out of the reach of the babies, children and domestic animals.
- Carefully attach the stand to the TV. If the stand is provided with screws, tighten the screws firmly to prevent the TV from tilting. Do not over-tighten the screws and mount the stand rubbers properly.
- Do not dispose of the batteries in fire or with hazardous or flammable materials.

**WARNING** - Batteries must not be exposed to excessive heat such as sunshine, fire or the like.

**WARNING** - Excessive sound pressure from earphones or headphones can cause hearing loss.

**ABOVE ALL - NEVER let anyone, especially children, push or hit the screen, push anything into holes, slots or any other openings in the case.**

Caution	Serious injury or death risk
Risk of electric shock	Dangerous voltage risk
Maintenance	Important maintenance component

### Markings on the Product

The following symbols are used on the product as a marker for restrictions and precautions and safety instructions. Each explanation shall be considered where the product bears related marking only. Note such information for security reasons.



**Class II Equipment:** This appliance is designed in such a way that it does not require a safety connection to electrical earth.



**Hazardous Live Terminal:** The marked terminal(s) is/are hazardous live under normal operating conditions.



**Caution, See Operating Instructions:** The marked area(s) contain(s) user replaceable coin or button cell batteries.



**Class 1 Laser Product:** This product contains Class 1 laser source that is safe under reasonably foreseeable conditions of operation.

## WARNING

Do not ingest the battery, Chemical Burn Hazard  
This product or the accessories supplied with the product may contain a coin/button cell battery. If the coin/button cell battery is swallowed, it can cause severe internal burns in just 2 hours and can lead to death.

Keep new and used batteries away from children.  
If the battery compartment does not close securely, stop using the product and keep it away from children.

If you think batteries might have been swallowed or placed inside any part of the body, seek immediate medical attention.

-----  
Never place a television set in unstable or inclined locations. A television set may fall, causing serious personal injury or death. Many injuries, particularly to children, can be avoided by taking simple precautions such as;

- Using cabinets or stands recommended by the manufacturer of the television set.
- Only using furniture that can safely support the television set.
- Ensuring the television set is not overhanging the edge of the supporting furniture.
- Not placing the television set on tall furniture (for example, cupboards or bookcases) without anchoring both the furniture and the television set to a suitable support.
- Not standing the television set on cloth or other materials placed between the television and supporting furniture.
- Educating children about the dangers of climbing on furniture to reach the television set or its controls. If your existing television set is being retained and relocated, the same considerations as above should be applied.

-----  
Apparatus connected to the protective earthing of the building installation through the MAINS connection or through other apparatus with a connection to protective earthing – and to a television distribution system using coaxial cable, may in some circumstances create a fire hazard. Connection to a television distribution system has therefore to be provided through a device providing electrical isolation below a certain frequency range (galvanic isolator)

## WALL MOUNTING WARNINGS

- Read the instructions before mounting your TV on the wall.
- The wall mount kit is optional. You can obtain from your local dealer, if not supplied with your TV.
- Do not install the TV on a ceiling or on an inclined wall.
- Use the specified wall mounting screws and other accessories.
- Tighten the wall mounting screws firmly to prevent the TV from fall. Do not over-tighten the screws.

## Environmental Information

This television is designed to be environment friendly. To reduce energy consumption, you can follow these steps:

If you set the **Energy Saving** to **Minimum**, **Medium**, **Maximum** or **Auto** the TV will reduce the energy consumption accordingly. If you like to set the **Backlight** to a fixed value set as **Custom** and adjust the **Backlight** (located under the **Energy Saving** setting) manually using Left or Right buttons on the remote. Set as **Off** to turn this setting off.

*Note: Available **Energy Saving** options may differ depending on the selected **Mode** in the **Settings>Picture** menu.*

The **Energy Saving** settings can be found in the **Settings>Picture** menu. Note that some picture settings will be unavailable to be changed.

If pressed Right button or Left button consecutively, "**Screen will be off in 15 seconds.**" message will be displayed on the screen. Select **Proceed** and press **OK** to turn the screen off immediately. If you don't press any button, the screen will be off in 15 seconds. Press any button on the remote or on the TV to turn the screen on again.

*Note: **Screen Off** option is not available if the Mode is set to **Game**.*

When the TV is not in use, please switch off or disconnect the TV from the mains plug. This will also reduce energy consumption.

## Features

- Remote controlled colour TV
- Fully integrated digital terrestrial TV (DVB-T-T2)
- HDMI inputs to connect other devices with HDMI sockets
- USB input
- OSD menu system
- Scart socket for external devices (such as DVD Players, PVR, video games, etc.)
- Stereo sound system

- Teletext
- Headphone connection
- Automatic programming system
- Manual tuning
- Automatic power down after up to eight hours
- Sleep timer
- Child lock
- Automatic sound mute when no transmission
- NTSC playback
- AVL (Automatic Volume Limiting)
- PLL (Frequency Search)
- PC input
- Game Mode (Optional)
- Picture off function
- Ethernet (LAN) for interactive services available on digital channels

### Accessories Included

- Remote Control
- Batteries: 2 x AAA
- Instruction Book
- Quick Start Guide

### Standby Notifications

If the TV does not receive any input signal (e.g. from an aerial or HDMI source) for 3 minutes, it will go into standby. When you next switch-on, the following message will be displayed: **“TV switched to stand-by mode automatically because there was no signal for a long time.”**

The **Auto TV OFF** option (in the **Settings>System>More** menu) could have been set to a value between 1 and 8 hours by default. If this setting is not set as **Off** and the TV has been left on and not been operated during the set time, it will switch into standby mode after the set time has expired. When you next switch-on the TV, the following message will be displayed. **“TV switched to stand-by mode automatically because no operation was made for a long time.”** Before the TV switches into standby mode a dialogue window will be displayed. If you do not press any button the TV will switch into the standby mode after a waiting period of about 5 minutes. You can highlight **Yes** and press **OK** to switch the TV into standby mode immediately. If you highlight **No** and press **OK**, the TV will remain on. You can also choose to cancel the **Auto TV OFF** function from this dialogue. Highlight **Disable** and press **OK**, the TV will remain on and the function will be cancelled. You can enable this function again by changing the setting of the **Auto TV OFF** option from the **Settings>System>More** menu.

### TV Control Switch & Operation

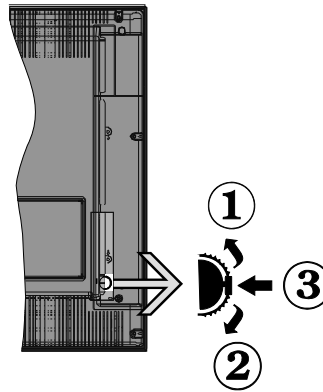

1. Up direction
  2. Down direction
  3. Volume / Info / Sources List selection and Standby-On switch
- The Control button allows you to control the Volume / Programme / Source and Standby-On

functions of the TV.

**To change volume:** Increase the volume by pushing the button up. Decrease the volume by pushing the button down.

**To change channel:** Press the middle of the button in, the information banner will appear on the screen. Scroll through the stored channels by pushing the button up or down.

**To change source:** Press the middle of the button in twice (for the second time in total), the source list will appear on the screen. Scroll through the available sources by pushing the button up or down.

**To turn the TV off:** Press the middle of the button in and hold it down for a few seconds, the TV will turn into standby mode.

**To turn on the TV:** Press the middle of the button in, the TV will turn on.

#### Notes:

*If you turn the TV off, this cycle starts again beginning with the volume setting.*

*Main menu OSD cannot be displayed via control button.*

### Operation with the Remote Control

Press the **Home** button on your remote control to display main menu. Use the directional buttons and **OK** button to navigate and set. Press **Return/Back** or **Home** button to quit a menu screen.

### Input Selection

Once you have connected external systems to your TV, you can switch to different input sources. Press the **Source** button on your remote control consecutively to select the different sources.

### Changing Channels and Volume

You can change the channel and adjust the volume by using the **Programme +/-** and **Volume +/-** buttons on the remote.

## Using Main TV Menu

When the **Home** button is pressed, the main TV menu will appear at the bottom of the screen. You can navigate through the menu items using the directional buttons on the remote. To select an item or see the sub-menu options of the highlighted menu press **OK** button. When you highlight a menu option some of the sub-menu items of this menu may appear on the upper side of the menu bar for quick access. To use a quick access item highlight it, press **OK** and set as desired using the Left/Right directional buttons. When finished press **OK** or **Back/Return** button to exit.

Press **Exit** button to close the main menu.

### 1. Home

When main menu is opened **Home** menu bar will be highlighted. The content of the **Home** menu can be customised by adding options from other menus. Just highlight an option and press the Down direction button on the remote. If you see **Add to Home** option you can add it to the **Home** menu. Same way you can delete or change the position of any item in the **Home** menu. Press the Down direction button and select **Delete** or **Move** option and press **OK**. In order to move a menu item use the Right and Left direction buttons to select the position that you want the item to move to and press **OK**.

### 2. TV

#### 2.1. Guide

You can access the electronic programme guide menu using this option. Refer to **Electronic Programme Guide** section for more information.

#### 2.2. Channels

You can access the **Channels** menu using this option. Refer to **Using the Channel List** section for more information.

#### 2.3. Timers

You can set timers for future events using the options of this menu. You can also review the previously created timers under this menu.

To add a new timer select the **Add Timer** tab using the Left/Right buttons and press **OK**. Set the sub-menu options as desired and when finished press **OK**. A new timer will be created.

To edit a previously created timer, highlight that timer, select the **Edit Selected Timer** tab and press **OK**. Change the sub-menu options as desired and press **OK** to save your settings.

To cancel an already set timer, highlight that timer, select **Delete Selected Timer** tab and press **OK**. A confirmation message will be displayed. Highlight **Yes** and press **OK** to proceed. The timer will be cancelled.

It is not possible to set timers for two or more events that will be broadcasted in different channels at the same time interval. In this case you will be asked to choose one of these timers and cancel others. Highlight the timer you want to cancel and press **OK**, **Options** menu will be displayed. Then highlight **Set/Cancel** and press **OK** to cancel that timer. You will have to save changes after that. In order to do that press **OK**, highlight **Save Changes** and press **OK** again.

### 3. Settings

You can manage the settings of your TV using the options of this menu. Refer to **Settings Menu Contents** section for more information.

### 4. Sources

You can manage your input source references using the options of this menu. To change the current source highlight one of the options and press **OK**.

#### 4.1. Source Settings

Edit the names, enable or disable selected source options.

### Inserting the Batteries into the Remote

Remove the back cover to reveal the battery compartment. Insert two size **AAA** batteries. Make sure the (+) and (-) signs match (observe correct polarity). Do not mix old and new batteries. Replace only with same or equivalent type. Place the cover back on.

A message will be displayed on the screen when the batteries are low and must be replaced. Note that when the batteries are low, the performance of the remote control may be impaired.

Batteries should not be exposed to excessive heat such as sunshine, fire or the like.

### Power Connection

**IMPORTANT:** The TV set is designed to operate on a **220-240V AC, 50 Hz** supply. After unpacking, allow the TV set to reach the ambient room temperature before you connect the set to the mains. Plug the power cable to the mains socket outlet.

### Antenna Connection

Connect the aerial or cable TV plug to the **AERIAL INPUT (ANT.)** socket located on the rear side of the TV.

#### Rear side of the TV

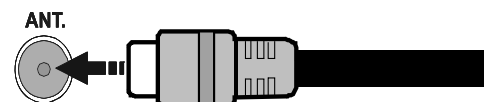

If you want to connect a device to the TV, make sure that both the TV and the device are turned off before making any connection. After the connection is done, you can turn on the units and use them.



## License Notification

The terms HDMI, HDMI High-Definition Multimedia Interface, and the HDMI Logo are trademarks or registered trademarks of HDMI Licensing Administrator, Inc.



Manufactured under license from Dolby Laboratories. Dolby, Dolby Audio and the double-D symbol are trademarks of Dolby Laboratories. Confidential unpublished works. Copyright ©1992-2019 Dolby Laboratories. All rights reserved.

The "CI Plus" Logo is a trademark of CI Plus LLP.

## Disposal Information

### [European Union]

These symbols indicate that the electrical and electronic equipment and the battery with this symbol should not be disposed of as general household waste at its end-of-life. Instead, the products should be handed over to the applicable collection points for the recycling of electrical and electronic equipment as well as batteries for proper treatment, recovery and recycling in accordance with your national legislation and the Directive 2012/19/EU and 2013/56/EU.

By disposing of these products correctly, you will help to conserve natural resources and will help to prevent potential negative effects on the environment and human health which could otherwise be caused by inappropriate waste handling of these products.

For more information about collection points and recycling of these products, please contact your local municipal office, your household waste disposal service or the shop where you purchased the product.

Penalties may be applicable for incorrect disposal of this waste, in accordance with national legislation.

### [Business users]

If you wish to dispose of this product, please contact your supplier and check the terms and conditions of the purchase contract.

### [Other Countries outside the European Union]

These symbols are only valid in the European Union. Contact your local authority to learn about disposal and recycling.

The product and packaging should be taken to your local collection point for recycling.

Some collection points accept products free of charge.

**Note:** The sign Pb below the symbol for batteries indicates that this battery contains lead.



1. Products
2. Battery

## Specification



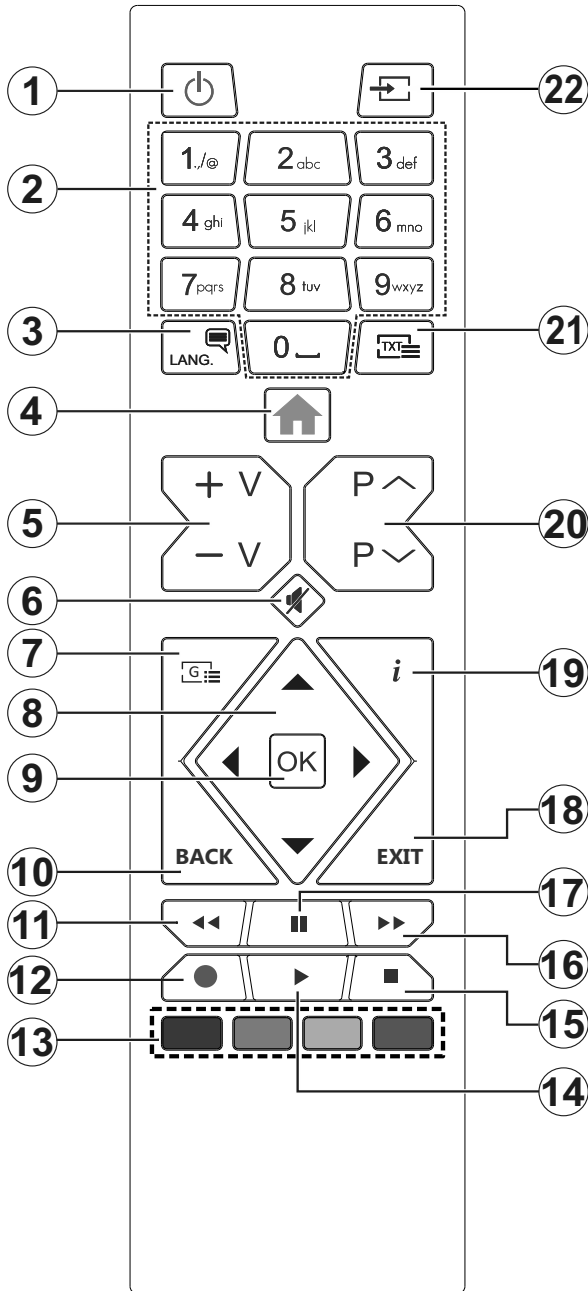







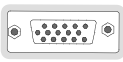





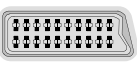



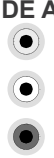





<b>TV Broadcasting</b>	PAL BG/I/DK SECAM BG/DK
<b>Receiving Channels</b>	VHF (BAND I/III) - UHF (BAND U) - HYPERBAND
<b>Digital Reception</b>	Fully integrated digital terrestrial TV (DVB-T) (DVB-T2 compliant)
<b>Number of Preset Channels</b>	1 000
<b>Channel Indicator</b>	On Screen Display
<b>RF Aerial Input</b>	75 Ohm (unbalanced)
<b>Operating Voltage</b>	220-240V AC, 50Hz.
<b>Audio</b>	German+Nicam Stereo
<b>Audio Output Power (WRMS.) (10% THD)</b>	2 x 2,5
<b>Power Consumption (W)</b>	45
<b>TV Dimensions DxLxH (with stand) (mm)</b>	135 x 553 x 365
<b>TV Dimensions DxLxH (without stand) (mm)</b>	41/63 x 553 x 334
<b>Display</b>	24"
<b>Operation temperature and operation humidity</b>	0°C up to 40°C, 85% humidity max

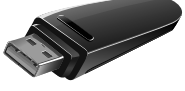
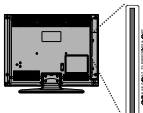

1. **Standby:** Switches On / Off the TV
2. **Numeric buttons:** Switches the channel, enters a number or a letter in the text box on the screen.
3. **Language:** Displays and changes audio/subtitle language and turns subtitles on or off (digital TV, where available)
4. **Home:** Displays TV menu
5. **Volume +/-**
6. **Mute:** Completely turns off the volume of the TV
7. **Guide:** Displays the electronic programme guide
8. **Directional buttons:** Helps navigate menus, content etc. and displays the subpages in TXT mode when pressed Right or Left
9. **OK:** Confirms user selections, holds the page (in TXT mode), views **Channels** menu (DTV mode)
10. **Back/Return:** Returns to previous screen, previous menu, opens index page (in TXT mode). Quickly cycles between previous and current channels or sources (depends on the model)
11. **Rewind:** Moves frames backwards in media such as movies
12. No function
13. **Coloured Buttons:** Follow the on-screen instructions for coloured button functions
14. **Play:** Starts to play selected media
15. **Stop:** Stops the media being played
16. **Fast Forward:** Moves frames forward in media such as movies
17. **Pause:** Pauses the media being played
18. **Exit:** Closes and exits from displayed menus or returns to previous screen
19. **Info:** Displays information about on-screen content, shows hidden information (reveal - in TXT mode)
20. **Programme +/-**
21. **Text:** Displays teletext (where available), press again to superimpose the teletext over a normal broadcast picture (mix)
22. **Source:** Shows available broadcast and content sources

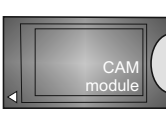

## Connections

Connector	Type	Cables	Device
	VGA Connection (back)		
AUDIO IN 	PC/YPbPr Audio Connection (side)	 YPbPr/PC Audio Cable	
	HDMI Connection (back)		
	Scart Connection (back)		
YPBPR 	YPbPr Video Connection (back)	 PC to YPbPr Connection Cable	
SIDE AV 	Side AV (Audio/Video) Connection (side)	 Audio/Video Cable	
SPDIF 	SPDIF (Coaxial Out) Connection (back)		
HEADPHONE 	Headphone Connection (side)		
	USB Connection (side)		
	CI Connection (side)		
LAN 	Ethernet Connection (back)	 LAN / Ethernet Cable	

See the illustrations on the left side. You can use YPbPr to VGA cable to enable YPbPr signal via VGA input. You cannot use VGA and YPbPr at the same time. To enable PC/YPbPr audio, you will need to use the side audio inputs with a YPbPr/PC audio cable for audio connection. If an external device is connected via the SCART socket, the TV may automatically switch to EXT1 mode. When receiving DTV channels (Mpeg4 H.264, H.265) or while in Media Browser mode, output will not be available via the scart socket. When using the wall mounting kit (available from a third party in the market, if not supplied), we recommend that you plug all your cables into the back of the TV before mounting on the wall. Insert or remove the CI module only when the TV is SWITCHED OFF. You should refer to the module instruction manual for details of the settings. The USB input of your TV supports devices up to 500mA. Connecting devices that have current value above 500mA may damage your TV. When connecting equipment using a HDMI cable to your TV, to guarantee sufficient immunity against parasitic frequency radiation, you have to use a high speed shielded (high grade) HDMI cable with ferrites.



If you want to connect a device to the TV, make sure that both the TV and the device are turned off before making any connection. After the connection is done, you can turn on the units and use them.

## Switching On/Off

### To Switch the TV On

Connect the power cord to a power source such as a wall socket (220-240V AC, 50 Hz).

To switch on the TV from standby mode either:

- Press the “” button, **Programme +/-** or a numeric button on the remote control.
- Press the middle of the side function switch on the TV in.

### To Switch the TV Off

Press the “” button on the remote control or press the middle of the side function switch on the TV in and hold it down for a few seconds, the TV will switch into standby mode.

**To power down the TV completely, unplug the power cord from the mains socket.**

## First Time Installation

When turned on for the first time, the language selection screen is displayed. Select the desired language and press **OK**. In the following steps of the installation guide, set your preferences using the directional buttons and **OK** button.

On the second screen set your country preference. Depending on the country selection you may be asked to set and confirm a PIN at this point. The selected PIN cannot be 0000. You have to enter it if you are asked to enter a PIN for any menu operation later.

You can activate **Store Mode** option in the next step. This option will configure your TV's settings for store environment and depending on the TV model being used, the supported features of it may be displayed on the side of the screen as an info banner. This option is intended only for store use. It is recommended to select **Home Mode** for home use. This option will be available in **Settings>System>More** menu and can be turned off/on later. Make your selection and press **OK** to continue.

The **Network/Internet Settings** menu will be displayed next. Please refer to **Wired Network Connection** section to configure a wired connection. After the settings are completed highlight **Next** and press **OK** button to continue.

On next screen you can set broadcast types to be searched, set your encrypted channel searching and time zone (depending on the country selection) preferences. Additionally you can set a broadcast type as your favourite one. Priority will be given to the selected broadcast type during the search process and the channels of it will be listed on the top of the channel list. When finished, highlight **Next** and press **OK** to continue.

## About Selecting Broadcast Type

To turn a search option for a broadcast type highlight it and press **OK**. The checkbox next to the selected option will be checked. To turn the search option off clear the checkbox by pressing **OK** after moving the focus on the desired broadcast type option.

**Digital Aerial:** If **D. Aerial** broadcast search option is turned on, the TV will search for digital terrestrial broadcasts after other initial settings are completed.

After the initial settings are completed TV will start to search for available broadcasts of the selected broadcast types.

While the search continues current scan results will be displayed at the bottom of the screen. After all the available stations are stored, **Channels** menu will be displayed. You can edit the channel list according to your preferences using the **Edit** tab options or press the **Home** button to quit and watch TV.

While the search continues a message may appear, asking whether you want to sort channels according to the LCN(\*). Select **Yes** and press **OK** to confirm.

(\* ) LCN is the Logical Channel Number system that organizes available broadcasts in accordance with a recognizable channel number sequence (if available).

**Note:** Do not turn off the TV while initializing first time installation. Note that, some options may not be available depending on the country selection.

## Media Playback via USB Input

You can connect 2.5" and 3.5" inch (HDD with external power supply) external hard disk drives or USB memory stick to your TV by using the USB inputs of the TV.

**IMPORTANT!** Back up the files on your storage devices before connecting them to the TV. Manufacturer will not be responsible for any file damage or data loss. Certain types of USB devices (e.g. MP3 Players) or USB hard disk drives/memory sticks may not be compatible with this TV. The TV supports FAT32 and NTFS disk formatting.

Wait a little while before each plugging and unplugging as the player may still be reading files. Failure to do so may cause physical damage to the USB player and the USB device itself. Do not pull out your drive while playing a file.

You can use USB hubs with your TV's USB inputs. External power supplied USB hubs are recommended in such a case.

It is recommended to use the TV's USB input(s) directly, if you are going to connect a USB hard disk.





**Note:** When viewing image files the **Media Browser** menu can only display 1000 image files stored on the connected USB device.

## Media Browser

You can play back music and movie files and display photo files stored on a USB storage device by connecting it to your TV. Connect a USB storage device to one of the USB inputs located on the side of the TV.

After connecting a USB storage device to your TV **Media Browser** menu will be displayed on the screen. You can access the content of the connected USB device any time later from the **Sources** menu. Select the related USB input option from this menu and press **OK**. Then select the file of your choice and press **OK** to display or play it back.

You can set your **Media Browser** preferences by using the **Settings** menu. **Settings** menu can be accessed via the information bar which is displayed on the bottom of the screen when pressed the **Info** button while playing back a video file or displaying a picture file. Press the **Info** button, highlight the gear wheel symbol positioned on the right side of the information bar and press **OK**. **Picture Settings**, **Sound Settings**, **Media Browser Settings** and **Options** menus will be available. The contents of these menus may change according to the type of the currently open media file. Only **Sound Settings** menu will be available while playing back audio files.

Loop/Shuffle Mode Operation	
Start playback and activate 	All files in the list will be continuously played in original order
Start playback and activate 	The same file will be played continuously (repeat)
Start playback and activate 	All files in the list will be played once in random order
Start playback and activate 	All files in the list will be continuously played in the same random order

To use the functions on the information bar highlight the symbol of the function and press **OK**. To change the status of a function highlight the symbol of the function and press **OK** as much as needed. If the symbol is marked with a red cross, that means it is deactivated.

## CEC

This function allows to control the CEC-enabled devices, that are connected through HDMI ports by using the remote control of the TV.

The **CEC** option in the **Settings>System>More** menu should be set as **Enabled** at first. Press the **Source** button and select the HDMI input of the connected CEC device from the **Sources List** menu. When new CEC source device is connected, it will be listed in source menu with its own name instead of the connected HDMI ports name(such as DVD Player, Recorder 1 etc.).

The TV remote is automatically able to perform the main functions after the connected HDMI source has been selected. To terminate this operation and control the TV via the remote again, press and hold the "0-Zero" button on the remote control for 3 seconds.

You can disable the CEC functionality by setting the related option under the **Settings>System>More** menu accordingly.

The TV supports ARC (Audio Return Channel). This feature is an audio link meant to replace other cables between the TV and an audio system (A/V receiver or speaker system).

When ARC is active, the TV does not mute its other audio outputs automatically. You will need to decrease TV volume to zero manually if you wish to hear the ARC audio only (same as optical or co-axial digital audio outputs). If you want to change connected device's volume level, you should select that device from the source list. In that case volume control keys are directed to connected audio device.

**Note:** ARC is supported only via the HDMI1 input.

### System Audio Control

Allows an Audio Amplifier/Receiver to be used with the TV. The volume can be controlled using the remote control of the TV. To activate this feature set the **Speakers** option in the **Settings>System>More** menu as **Amplifier**. The TV speakers will be muted and the sound of the watched source will be provided from the connected sound system.

**Note:** The audio device should support System Audio Control feature and **CEC** option should be set as **Enabled**.

## Settings Menu Contents

Picture Menu Contents	
<b>Mode</b>	You can change the picture mode to suit your preference or requirements. Picture mode can be set to one of these options: <b>Cinema</b> , <b>Game</b> (optional), <b>Sports</b> , <b>Dynamic</b> and <b>Natural</b> .
<b>Contrast</b>	Adjusts the light and dark values on the screen.
<b>Brightness</b>	Adjusts the brightness values on the screen.
<b>Sharpness</b>	Sets the sharpness value for the objects displayed on the screen.
<b>Colour</b>	Sets the colour value, adjusting the colours.
<b>Energy Saving</b>	For setting the <b>Energy Saving</b> to <b>Custom</b> , <b>Off</b> , <b>Minimum</b> , <b>Medium</b> , <b>Maximum</b> , <b>Auto</b> , <b>Screen off</b> . <i>Note: Available options may differ depending on the selected Mode.</i>
<b>Backlight</b>	This setting controls the backlight level. The backlight function will be inactive if the <b>Energy Saving</b> is set to an option other than <b>Custom</b> .
<b>Advanced Settings</b>	
<b>Dynamic Contrast</b>	You can change the dynamic contrast ratio to desired value.
<b>Noise Reduction</b>	If the signal is weak and the picture is noisy, use the <b>Noise Reduction</b> setting to reduce the amount of noise.
<b>Colour Temp</b>	Sets the desired colour temperature value. <b>Cool</b> , <b>Normal</b> , <b>Warm</b> and <b>Custom</b> options are available.
<b>White Point</b>	If the <b>Colour Temp</b> option is set as <b>Custom</b> , this setting will be available. Increase the 'warmth' or 'coolness' of the picture by pressing Left or Right buttons.
<b>Picture Zoom</b>	Sets the desired image size format.
<b>Picture Shift</b>	This option may be available depending on the <b>Picture Zoom</b> setting. Highlight and press <b>OK</b> , then use directional buttons to shift the picture upwards or downwards.
<b>Film Mode</b>	Films are recorded at a different number of frames per second to normal television programmes. Turn this feature on when you are watching films to see the fast motion scenes clearly.
<b>Skin Tone</b>	Skin tone can be changed between -5 and 5.
<b>Colour Shift</b>	Adjust the desired colour tone.
<b>HDMI Full Range</b>	While watching from a HDMI source, this feature will be visible. You can use this feature to enhance blackness in the picture.
<b>PC Position</b>	Appears only when the input source is set to VGA/PC.
<b>Autoposition</b>	If the image is not centered in VGA mode use this option to automatically adjust the position of the image. Press <b>OK</b> to start the auto adjustment.
<b>H Position</b>	This item shifts the image horizontally to the right hand side or left hand side of the screen.
<b>V Position</b>	This item shifts the image vertically towards the top or bottom of the screen.
<b>Dot Clock</b>	Dot Clock adjustments correct the interference that appear as vertical banding in dot intensive presentations like spreadsheets or paragraphs or text in smaller fonts.
<b>Phase</b>	Depending on the input source(computer etc.) you may see a hazy or noisy picture on the screen. You can use phase to get a clearer picture by trial and error.
<b>Reset</b>	Resets the picture settings to factory default settings (except <b>Game</b> mode).
<i>While in VGA (PC) mode, some items in <b>Picture</b> menu will be unavailable. Instead, VGA mode settings will be added to the <b>Picture</b> menu while in PC mode.</i>	

Sound Menu Contents	
<b>Volume</b>	Adjusts the volume level.
<b>Equalizer</b>	Selects the equalizer mode. Custom settings can be made only when in <b>User</b> mode.
<b>Balance</b>	Adjusts whether the sound comes from the left or right speaker.
<b>Headphone</b>	Sets headphone volume. Please ensure before using headphones that the headphone volume is set to a low level, to prevent damage to your hearing.
<b>Sound Mode</b>	You can select a sound mode (If the viewed channel supports).
<b>AVL (Automatic Volume Limiting)</b>	Sets the sound to obtain fixed output level between programmes.
<b>Headphone/Lineout</b>	When you connect an external amplifier to your TV using the headphone jack, you can select this option as <b>Lineout</b> . If you have connected headphones to the TV, set this option as <b>Headphone</b> . Please ensure before using headphones that this menu item is set to <b>Headphone</b> . If it is set to <b>Lineout</b> , the output from the headphone socket will be set to maximum which could damage your hearing.
<b>Dynamic Bass</b>	Enables or disables the Dynamic Bass.
<b>Surround sound</b>	Surround sound mode can be changed as <b>On</b> or <b>Off</b> .
<b>Digital Out</b>	Sets digital out audio type.

Network Menu Contents	
<b>Network Type</b>	Disable or enable the wired network connection.
<b>Internet Speed Test</b>	Start a speed test to check your connection bandwidth. The result will be displayed on the screen when finished.
<b>Advanced Settings</b>	Change the IP and DNS configurations of your TV.
<i>Note: For detailed information on the options of this menu refer to the <b>Wired Network Connection</b> section.</i>	

Installation Menu Contents	
<b>Automatic channel scan (Retune)</b>	Displays automatic tuning options. <b>Digital Aerial:</b> Searches and stores aerial DVB stations.
<b>Manual Channel Scan</b>	This feature can be used for direct broadcast entry.
<b>Network Channel Scan</b>	Searches for the linked channels in the broadcast system. <b>Digital Aerial:</b> Searches for aerial network channels.
<b>Installation Settings (optional)</b>	Displays installation settings menu. <b>Standby Search (*):</b> Your TV will search for new or missing channels while in standby. Any new found broadcasts will be shown. <b>Dynamic Channel Update(*):</b> If this option is set as Enabled, the changes on the broadcasts such as frequency, channel name, subtitle language etc., will be applied automatically while watching. <i>(*) Availability depends on model.</i>
<b>Clear Service List</b>	Use this setting to clear channels stored. This setting is visible only when the <b>Country</b> option is set to Denmark, Sweden, Norway or Finland.
<b>Select Active Network</b>	This setting allows you to select only the broadcasts within the selected network to be listed in the channel list. This feature is available only for the country option of Norway.
<b>Signal Information</b>	You can use this menu item to monitor signal related information such as signal level/quality, network name etc for available frequencies.
<b>First time installation</b>	Deletes all stored channels and settings, resets TV to factory settings.



System Menu Contents	
<b>Conditional Access</b>	Controls conditional access modules when available.
<b>Language</b>	You may set a different language depending on the broadcaster and the country.
<b>Parental</b>	Enter correct password to change parental settings. You can easily adjust <b>Menu Lock</b> , <b>Maturity Lock</b> , <b>Child Lock</b> or <b>Guidance</b> in this menu. You can also set a new <b>PIN</b> or change the <b>Default CICAM PIN</b> using the related options. <i>Note: Some menu options may not be available depending on the country selection in the <b>First Time Installation</b>. Default PIN could have been set to 0000 or 1234. If you have defined the PIN(is requested depending on the country selection) during the <b>First Time Installation</b> use the PIN that you have defined.</i>
<b>Date/Time</b>	Sets date and time.
<b>Sources</b>	Edit the names, enable or disable selected source options.
<b>Accessibility</b>	Displays accessibility options of the TV.
<b>Hard of Hearing</b>	Enables any special feature sent from the broadcaster.
<b>Audio Description</b>	A narration track will be played for the blind or visually impaired audience. Press <b>OK</b> to see all available <b>Audio Description</b> menu options. This feature is available only if the broadcaster supports it.
<b>More</b>	Displays other setting options of the TV.
<b>Menu Timeout</b>	Changes timeout duration for menu screens.
<b>Standby LED</b>	If set as <b>Off</b> the standby LED will not light up when the TV is in standby mode.
<b>Software Upgrade</b>	Ensures that your TV has the latest firmware. Press <b>OK</b> to see the menu options.
<b>Application Version</b>	Displays current software version.
<b>Subtitle Mode</b>	This option is used to select which subtitle mode will be on the screen ( <b>DVB</b> subtitle / <b>Teletext</b> subtitle) if both is available. Default value is <b>DVB</b> subtitle. This feature is available only for the country option of Norway.
<b>Auto TV OFF</b>	Sets the desired time for the TV to automatically go into standby mode when not being operated. This option can be set from 1 to 8 hours in steps of 1 hour. You can also disable this option by setting as <b>Off</b> .
<b>Store Mode</b>	Select this mode for store display purposes. Whilst <b>Store Mode</b> is enabled, some items in the TV menu may not be available.
<b>Power Up Mode</b>	This setting configures the power up mode preference. <b>Last State</b> and <b>Standby</b> options are available.
<b>CEC</b>	With this setting you can enable and disable CEC functionality completely. Press Left or Right button to enable or disable the feature.
<b>CEC Auto Power On</b>	This function allows the connected HDMI-CEC compatible device to turn on the TV and switch to its input source automatically. Press <b>Left</b> or <b>Right</b> button to enable or disable the feature.
<b>Speakers</b>	To hear the TV audio from the connected compatible audio device set as <b>Amplifier</b> . You can use the remote control of the TV to control the volume of the audio device.
<b>OSS</b>	Displays Open Source Software license information.

## General TV Operation

### Using the Channel List

The TV sorts all stored stations in the channel list. You can edit this channel list, set favourites or set active stations to be listed by using the **Channels** menu options. Press the **OK** button to open the channel list. You can filter the listed channels or make advanced changes in the current list using the **Filter** and **Edit** tab options. Highlight the tab you want and press **OK** to see available options.

### Managing the Favourite Lists

You can create four different lists of your favourite channels. Enter the **TV>Channels** menu or press the **OK** button in order to open the **Channels** menu. Highlight the **Edit** tab and press **OK** to see the editing options and select the **Tag/Untag channel** option. Select the desired channel on the list by pressing the **OK** button while the channel is highlighted. You can make multiple choices. You can also use the **Tag/Untag all** option to select all channels on the list. Then press **Back/Return** button to return to the Edit menu options. Select **Add/Remove Favourites** option and press the **OK** button again. Favourite channel list options will be displayed. Set the desired list option to **On**. The selected channel/s will be added to the list. In order to remove a channel or channels from a favourite list follow the same steps and set the desired list option to **Off**.

You can use the filtering function in the **Channels** menu to filter the channels in the channel list permanently according to your preferences. For instance, using the options of the **Filter** tab, you can set one of your four favourite lists to be displayed every time the channel list is opened.

### Configuring Parental Settings

The **Parental** menu options can be used to prohibit users from viewing of certain programmes, channels and using of menus. These settings are located in the **Settings> System>Parental** menu.

To display parental lock menu options, a PIN should be entered. After coding the correct PIN, **Parental** menu will be displayed.

**Menu Lock:** This setting enables or disables access to all menus or installation menus of the TV.

**Guidance:** This setting enables or disables access some of the MHEG applications. Disabled applications can be released by entering the right PIN.

**Set PIN:** Defines a new PIN number.

**Default CICAM PIN:** This option will appear as greyed out if no CI module is inserted into the CI slot of the TV. You can change the default PIN of the CI CAM using this option.

*Note: Default PIN could have been set to 0000 or 1234. If you have defined the PIN(is requested depending on the country selection) during the **First Time Installation** use the PIN that you have defined.*

*Some options may not be available depending on the model and/or on the country selection in the **First Time Installation**.*

### Electronic Programme Guide

By means of electronic programme guide function of your TV you can browse the event schedule of the currently installed channels on your channel list. It depends on the related broadcast whether this feature is supported or not.

To access the programme guide, press the **Guide** button on your remote. You can also use the **Guide** option under **TV** menu.

There are 2 different types of schedule layouts available, **Timeline Schedule** and **Now/Next**. To switch between these layouts highlight the tab with the name of the alternative layout on the upper side of the screen and press **OK**.

Use the directional buttons to navigate through the programme guide. Use the **Back/Return** button to use the tab options on the upper side of the screen.

### Timeline Schedule

In this layout option, all events of the listed channels will be displayed by timeline. You can use the directional buttons to scroll through the list of the events. Highlight an event and press **OK** to display event options menu.

Press **Back/Return** button to use available tab options. Highlight **Filter** tab and press **OK** to see the filtering options. To change the layout highlight **Now/Next** and press **OK**. You can use the **Previous Day** and **Next Day** options to display the events of the previous and next day.

Highlight **Extras** tab and press **OK** to access below options.

**Highlight Genre:** Displays **Highlight Genre** menu. Select a genre and press **OK**. The events in the programme guide matching the selected genre will be highlighted.

**Guide Search:** Displays searching options. Using these options, you can search the programme guide database in accordance with the selected criteria. Matching results will be listed.

**Now:** Displays current event of the highlighted channel.

**Zoom:** Highlight and press **OK** to see events in a wider time interval.

### Now/Next Schedule

In this layout option, only the current and next events of the listed channels will be displayed. You can use the directional buttons to scroll through the list of the events.

Press **Back/Return** button to use available tab options. Highlight **Filter** tab and press **OK** to see the filtering options. To change the layout highlight **Timeline Schedule** and press **OK**.

### Event Options

Use the directional buttons to highlight an event and press **OK** button to display **Options** menu. The following options are available.

**Select Channel:** Using this option, you can switch to the selected channel in order to watch it. The programme guide will be closed.

**More Info:** Display detailed information on the selected event. Use up and down directional buttons to scroll through the text.

**Set Timer on Event / Delete Timer on Event:** Select **Set Timer on Event** option and press **OK**. You can set timers for future events. To cancel an already set timer, highlight that event and press the **OK** button. Then select **Delete Timer on Event** option. The timer will be cancelled.

**Notes:** You cannot switch to any other channel while there is an active timer on the current channel.

*It is not possible to set timer for two or more individual events at the same time interval.*

### Teletext Services (where available)

Press the **Text** button to enter. Press again to activate mix mode, which allows you to see the teletext page and the TV broadcast at the same time. Press once more to exit. If available, sections in the teletext pages will become colour-coded and can be selected by pressing the coloured buttons. Follow the instructions displayed on the screen.

### Digital Teletext

Press the **Text** button to view digital teletext information. Operate it with the coloured buttons, cursor buttons and the **OK** button. The operation method may differ depending on the contents of the digital teletext. Follow the instructions displayed on the digital teletext screen. When the **Text** button is pressed again, the TV returns to television broadcast.

### MHEG Teletext

With digital terrestrial broadcasting (DVB-T), in addition to pictures and sound, you can also view digital teletext. Digital teletext is sometimes broadcast at the same time with the normal broadcasting.

- Press the **Text** or **Red** button
- The digital teletext information appears
- Operate it with the coloured buttons, directional buttons and **OK** button

The operation method may differ depending on the contents of the digital teletext. Follow the instructions displayed on digital teletext screen. Press the **Text** button to return to television broadcast.

## Troubleshooting & Tips

### TV will not turn on

Make sure the power cord is plugged in securely to a wall outlet. Press the Power button on the TV.

### Poor picture

- Check if you have correctly tuned the TV.
- Low signal level can cause picture distortion. Please check antenna connections.
- Check if you have entered the correct channel frequency if you have performed manual tuning.

### No picture

- TV is not receiving any signal. Make sure the correct source has been selected.
- Is the antenna connected properly?
- Is the antenna cable damaged?
- Are suitable plugs used to connect the antenna?
- If you are in doubt, consult your dealer.

### No sound

- Check if the TV sound is muted. Press the **Mute** button or increase the volume to check.
- Sound may be coming from only one speaker. Check the balance settings from Sound menu.

### Remote control - no operation

- The batteries may be exhausted. Replace the batteries.
- The batteries maybe inserted incorrectly. Refer to the section "Inserting the Batteries into the Remote".

### No signal on an input source

- It is possible that no device is connected.
- Check the AV cables and connections from your device.
- Check the device is switched on.

### The Image is not centered in VGA source

To have your TV automatically center the image, enter the **PC Position** menu in **Picture** menu, highlight **Autoposition** and press **OK**. Wait for it to finish. In order to set the position of the image manually you can use **H Position** and **V Position** options. Select the desired option and use Left and Right directional buttons on the remote to set. PC Input Typical Display Modes

The following table is an illustration of some of the typical video display modes. Your TV may not support all resolutions.

Index	Resolution	Frequency
1	640x480	60 Hz
2	800x600	56 Hz
3	800x600	60 Hz
4	1024x768	60 Hz
5	1024x768	66 Hz
6	1280x768	60 Hz
7	1280x960	60 Hz
8	1280x1024	60 Hz
9	1360x768	60 Hz
10	1400x1050	60 Hz
11	1600x1200	60 Hz
12	1920x1080	60 Hz

### AV and HDMI Signal Compatibility

Source	Supported Signals	Available	
EXT (SCART)	PAL 50/60	O	
	NTSC 60	O	
	RGB 50	O	
	RGB 60	O	
Side AV	PAL 50/60	O	
	NTSC 60	O	
PC/YPbPr	480I, 480P	60Hz	O
	576I, 576P	50Hz	O
	720P	50Hz,60Hz	O
	1080I	50Hz,60Hz	O
	1080P	50Hz,60Hz	O
HDMI	480I	60Hz	O
	480P	60Hz	O
	576I, 576P	50Hz	O
	720P	50Hz,60Hz	O
	1080I	50Hz,60Hz	O
	1080P	24Hz, 25Hz 30Hz, 50Hz, 60Hz	O

(X: Not Available, O: Available)

In some cases a signal on the TV may not be displayed properly. The problem may be an inconsistency with standards from the source equipment (DVD, Set-top box, etc. ). If you do experience such a problem please contact your dealer and also the manufacturer of the source equipment.

## Supported File Formats for USB Mode

Media	Extension	Format	Notes
Video	.mpg, .mpeg	MPEG1-2	MPEG1: 768x576 @ 30P, MPEG2:1920x1080 @ 30P
	.vob	MPEG2	1920x1080 @ 30P
	.mp4	MPEG4, Xvid, H.264	
	.mkv	H.264, MPEG4,VC-1	
	.avi	MPEG2, MPEG4, Xvid, H.264	
	.flv	H.264/VP6/ Sorenson	H.264/VP6: 1920x1080 @ 30P Sorenson: 352x288 @ 30P
	.mp4, .mov, .3gpp, .3gp, MPEG transport stream, .ts,.trp, .tp, .mkv	HEVC/H.265	1080P@60fps - 50Mbps
	.3gp	MPEG4 , H.264	1920x1080 @ 30P
Audio	.mp3	MPEG1 Layer 2/3	Layer2: 32Kbps ~ 448Kbps (Bit rate) / 32kHz, 44.1kHz, 48kHz, 16kHz, 22.05kHz, 24kHz (Sampling rate) Layer3: 32Kbps ~ 320Kbps (Bit rate) / 32kHz, 44.1kHz, 48kHz, 16kHz, 22.05kHz, 24kHz, 8kHz, 11.025kHz, 12kHz (Sampling rate)
	(works only with video files)	AC3	32Kbps ~ 640Kbps (Bit rate) / 32kHz, 44.1kHz, 48kHz (Sampling rate)
		AAC	16Kbps ~ 576Kbps (Bit rate) / 48kHz, 44.1kHz, 32kHz, 24kHz, 22.05kHz, 16kHz, 12kHz, 11.025kHz, 8kHz (Sampling rate)
		EAC3	32Kbps ~ 6Kbps (Bit rate) / 32kHz, 44.1kHz, 48kHz (Sampling rate)
		LPCM	Unsigned 8bit PCM, Signed/Unsigned 16bit PCM (big / little endian), 24bit PCM (big endian), DVD LPCM 16/20/24bit (Bit rate) / 6kHz, 8kHz, 11.025kHz, 12kHz, 16kHz, 22.05kHz, 24kHz, 32kHz, 44.1kHz, 48kHz , 88.2kHz, 96kHz, 176.4kHz, 192kHz (Sampling rate)
		IMA-ADPCM/ MS-ADPCM	384Kbps (Bit rate) / 8KHz ~ 48Khz (Sampling rate)
		LBR	32Kbps ~ 96Kbps (Bit rate) / 32kHz, 44.1kHz, 48kHz (Sampling rate)
Picture	.jpeg	Baseline	Resolution(WxH): 17000x10000
		Progressive	Resolution(WxH): 4000x4000
	.bmp	-	Resolution(WxH): 5760x4096
Subtitle	.sub, .srt	-	-

## Supported DVI Resolutions

When connecting devices to your TV's connectors by using DVI converter cable(DVI to HDMI cable - not supplied), you can refer to the following resolution information.

	56Hz	60Hz	66Hz	70Hz	72Hz	75Hz
640x400				x		
640x480		x	x		x	x
800x600	x	x		x	x	x
832x624						x
1024x768		x	x	x	x	x
1152x864		x		x		x
1152x870						x
1280x768		x				x
1360x768		x				
1280x960		x				x
1280x1024		x				x
1400x1050		x				x
1440x900		x				x
1600x1200		x				
1680x1050		x				
1920x1080		x				



## Wired Network Connection

- You must have a modem/router connected to an active broadband connection.
- Connect your TV to your modem/router via an Ethernet cable. There is a LAN port at the rear (back) of your TV.

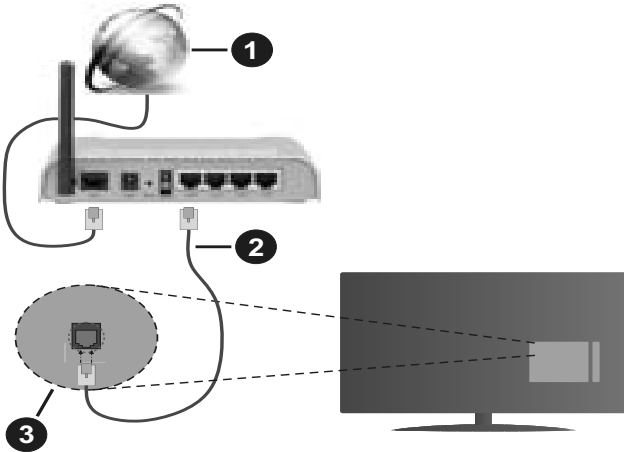

1. Broadband ISP connection
2. LAN (Ethernet) cable
3. LAN input on the rear side of the TV

To configure wired settings refer to the **Network** section in the **Settings** menu.

- You might be able to connect your TV to your LAN depending on your network's configuration. In such a case, use an Ethernet cable to connect your TV directly to the network wall outlet.

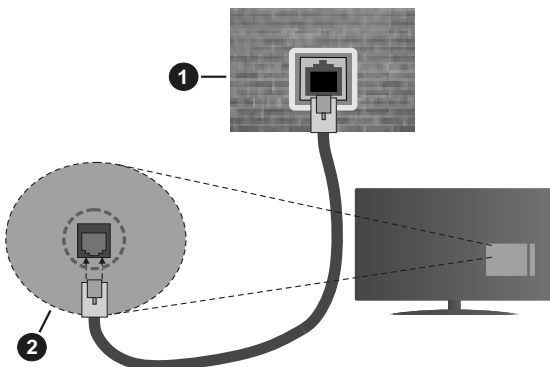

1. Network wall socket
2. LAN input on the rear side of the TV

## Configuring Wired Device Settings

### Network Type

The **Network Type** can be selected as **Wired Device** or **Disabled**, in accordance with the active connection to the TV set. Select this as **Wired Device** if you are connecting via an Ethernet cable.

## Internet Speed Test

Highlight **Internet Speed Test** and press the **OK** button. TV will check the internet connection bandwidth and display the result when complete.

## Advanced Settings

Highlight **Advanced Settings** and press the **OK** button. On the next screen you can change the IP and DNS settings of the TV. Highlight the desired one and press Left or Right button to change the setting from **Automatic** to **Manual**. Now you can enter the **Manual IP** and / or **Manual DNS** values. Select the related item in the drop down menu and enter the new values using the numeric buttons of the remote. Highlight **Save** and press the **OK** button to save settings when complete.

## Troubleshooting

### Internet Connection Not Available

If the MAC address (a unique identifier number) of your PC or modem has been permanently registered, it is possible that your TV might not connect to the internet. In such a case, the MAC address is authenticated each time when you connect to the internet. This is a precaution against unauthorized access. Since your TV has its own MAC address, your internet service provider cannot validate the MAC address of your TV. For this reason, your TV cannot connect to the internet. Contact your internet service provider and request information on how to connect a different device, such as your TV, to the internet.

It is also possible that the connection may not be available due to a firewall problem. If you think this causes your problem, contact your internet service provider.

## DVB functionality information

This DVB receiver is only suitable for use in the country which it was designed to be used in.

Although this DVB receiver conforms to the latest DVB specifications at the time of manufacture, we cannot guarantee compatibility with future DVB transmissions due to changes that may be implemented in broadcast signals and technologies.

Some digital television functions may not be available in all countries.

We continually strive to improve our products; therefore, specifications may change without prior notice.

For advice on where to purchase accessories, please contact the store where you purchased your equipment.

## DVD Mode

### Safety Information

#### CAUTION

DVD Player is a class 1 laser product. However this product uses a visible laser beam which could cause hazardous radiation exposure. Be sure to operate the player correctly as instructed.

**CLASS 1  
LASER PRODUCT**

#### RISK OF ELECTRIC SHOCK

The lightning flash with arrowhead symbol, within an equilateral triangle, is intended to alert the user to the presence of uninsulated "dangerous voltage" within the product's enclosure that may be of sufficient magnitude to constitute a risk of electric shock of persons.

The exclamation point within an equilateral triangle is intended to alert the user to the presence of important operating and maintenance (servicing) instructions in the literature accompanying the appliance.

#### Notes on Discs

##### On handling discs

- To keep the disc clean, handle the disc by its edge. Do not touch the surface.
- Do not stick paper or tape on the disc.
- If the disc is contaminated with any substance like glue remove before using it.

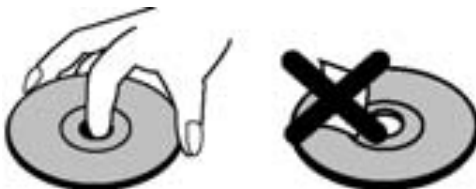

- Do not expose the disc to direct sunlight or heat sources such as hot air ducts, or leave it in a car parked in direct sunlight as the temperature can rise quickly and damage the disc.
- After playing, store the disc in its case.

##### On cleaning

- Before playing, clean the disc with a cleaning cloth. Wipe the disc from the centre out.

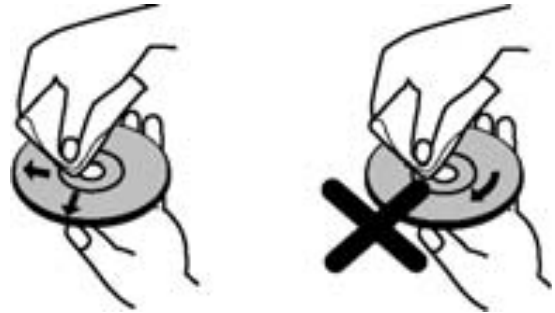

- Do not use solvents such as benzene, thinner, commercially available cleaners or anti-static spray intended for vinyl LPs.

#### How to Watch a DVD

When placing a disc into the loader, labelled side of the disc should be on the front.

When TV set is turned on, first switch to DVD source by using the **Source** button on the remote control. Press play on the remote control, or directly press play button on the side panel. If there is no disc inside the loader, place a DVD first and press play.

*Note: If you switch to another source by pressing **Source** or **Programme +/-** buttons on the remote control, DVD playback will be paused automatically. You should press **Play** button and resume the playback manually when you switch to DVD mode.*

#### DVD Control Panel Buttons

##### ▶ / || (Play / Pause)

Plays/pauses the disc. When DVD menu (root menu) is active, this button functions as "button select" (selects the highlighted item in menu) if this is not prohibited by the disc.

##### ■ / ▲ (Stop / Eject)

Stop playing disc / Eject or Load the disc.

*Note:*

*You cannot eject the disc via the remote control.*

*While playing a file, you should press **Stop** button three times to eject.*

#### General Playback

##### Basic Play

1. Press the **Standby** button
2. Insert a disc into the loader.

The disc will be automatically loaded and play will commence if the disc does not have any menus recorded on it.

A menu may appear on the TV screen after a few moments or the film may start immediately. This behaviour depends on the disc content and may change.

*Note: Step 3 and 4 are available only when a menu is recorded on the disc.*

3. Press **Down / Up / Left / Right** or the numeric button (s) to select the preferred title.
4. Press **OK** to confirm the selected item.

The played item may be a motion picture, a still picture or another submenu depending on the disc content.

### For your reference

If an action corresponding to a button is prohibited the “” symbol appears.

### Notes on Playback

1. No sound will be heard during fast forward or rewind.
2. No sound will be heard during slow motion play.
3. Reverse slow motion play may not be available depending on the DVD content.
4. In some cases, the subtitle language is not changed immediately to the selected one.
5. When the preferred language is not selected even after pressing the button several times, it means that the language is not available on the disc.
6. When the player is restarted or the disc is changed, the subtitle selection is automatically changed back to the initial settings.
7. If a language is selected, not supported by the disc, the subtitle language will automatically be set to the disc's priority language.
8. Usually a circulation will happen while switching to another subtitle, that is you can cancel the subtitle by pressing the **Text** button a number of times until “**Subtitles Off**” appears on the screen.
9. When the power is turned on or the disc is removed, the language heard is the one selected at the initial settings. If this language is not recorded on the disc, only the available language on the disc will be heard.
10. Some DVDs may not contain root and/or title menus.
11. Reverse stepping is not available.
12. For your convenience:  
If you attempt to enter a number greater than the total time of the current title, the time search box disappears and “ Input Invalid” message appears on upper-left corner of screen.
13. Slide Show is disabled when the ZOOM mode is on.

## DVD Troubleshooting

### Poor picture quality (DVD)

- Make sure the DVD disc surface is not damaged. (Scratch, fingerprint etc.)
- Clean the DVD disc and try again.

*See instructions described in “Notes on Discs” to clean your disc properly.*

- Ensure that the DVD disc is in the tray with the label facing forward.
- A damp DVD disc or condensation may affect the equipment. Wait for 1 to 2 hours in Stand-by to dry the equipment.

### Disc does not play

- No disc in the machine. Place a disc into the loader.
- Disc incorrectly loaded.

*Note: Ensure that the DVD disc is in the tray with the label facing forward.*

- Wrong type of disc. The machine cannot play CD-ROMS etc. The region code of the DVD must match the player.

### Wrong OSD language

- Select the language in the set-up menu.
- The language for the sound or subtitles on a DVD cannot be changed.
- Multilingual sound and/or subtitles not recorded on the DVD.
- Try to change the sound or subtitles using DVD's title menu. Some DVD's do not allow the user to change these settings without using the disc's menu
- These functions are not available on the DVD.

### No picture

- Make sure you have pressed the correct buttons on the remote control. Try once more.

### No sound

- Check if volume is set to an audible level.
- Make sure the sound isn't turned off by mistake.





### Distorted sound

- Check that the appropriate listening mode setting is correct.

### If nothing works

If you have tried the above solutions and none seem to work, try switching your TV-DVD off and on again. If this does not work, contact your supplier or TV-DVD repair technician. Never attempt to repair a defective TV-DVD yourself.

## Disc Types Compatible with This Unit

Disc Types (Logos)	Recording Types	Disc Size	Max. Playing Time	Characteristics
	Audio + Video	12 cm	Single-sided; 240 min. Double-sided; 480 min.	<ul style="list-style-type: none"> <li>DVD contains excellent sound and video due to Dolby Digital and MPEG-2 System.</li> <li>Various screen and audio functions can be easily selected through the on screen menu.</li> </ul>
	Audio	12 cm	74 min.	<ul style="list-style-type: none"> <li>An LP is recorded as an analog signal with more distortion. CD is recorded as a digital signal with better audio quality, less distortion and less deterioration of audio quality over time.</li> </ul>
	Audio (xxxx.mp3)	12 cm	It depends on MP3 quality.	<ul style="list-style-type: none"> <li>MP3 is recorded as a digital signal with better audio quality, less distortion and less deterioration of audio quality over time.</li> </ul>
	Video (still picture)	12 cm	It depends on JPEG quality.	<ul style="list-style-type: none"> <li>JPEG is recorded as a digital signal with better picture quality over time.</li> </ul>

For proper operation, only 12 cm discs must be used.

 is a trademark of DVD Format/Logo Licensing Corporation registered in the U.S., Japan and other countries.

## Specifications

<b>Types of Discs Supported</b>	<b>DVD:</b> SS/SL 4.7" (DVD-5) SS/DL 4.7" (DVD-9) DS/SL 4.7" (DVD-10) DS/DL 4.7" (DVD-18)	CD-DA CD-R CD-RW MP-3/JPEG
<b>Video Type</b>	MPEG-2 Video Standard Decoding (MPEG-1 supported) Full-Screen Video Display of 720 x 576 (PAL) & 720 x 480 (NTSC) pixels 50 and 60 Hz frame refresh rates (PAL & NTSC) Digital bit-stream processing rate up to 108Mbits/sec Line resolution more than 500 lines	
<b>Audio Type</b>	MPEG Multichannel Decoding LPCM	
<b>Audio Output</b>	<b>Analog Outputs:</b> 24 bit /48, 44.1kHz down-sampling DAC	



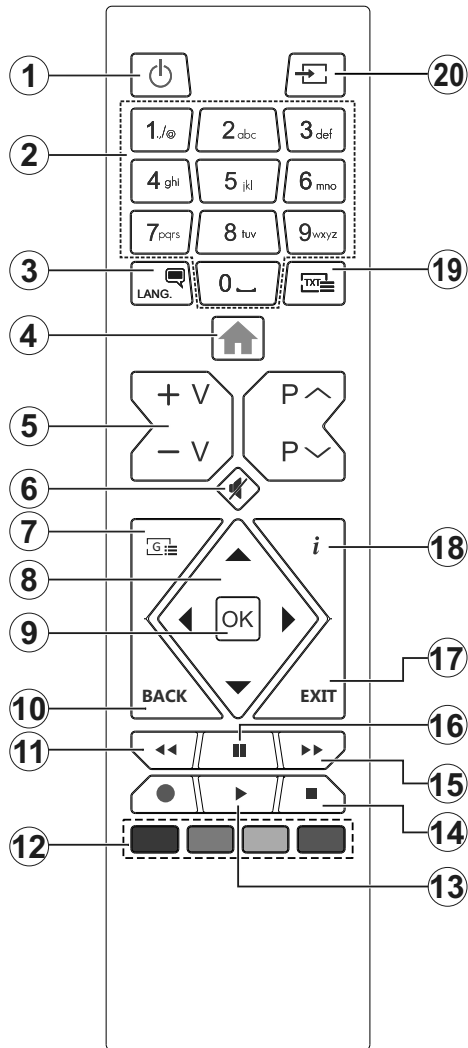



## Overview of the Remote Control







1. Standby
2. Numeric buttons
3. Audio language selection
4. TV Menu
5. Volume Up / Down
6. Mute
7. DVD menu
8. Navigation buttons
9. OK / Select
10. Back / Previous menu
11. Rewind
12. Coloured buttons;  
Red button - Zoom  
Green button - Repeat  
Yellow button - Root  
Blue button - Title
13. Play
14. Stop
15. Fast forward
16. Pause
17. Exit
18. Time
19. Subtitle language selection
20. Source selection

## General DVD Operation

You can operate DVD, movie CD, music or picture CD's content by using the proper buttons on your remote control. Below are main functions of commonly used remote control buttons.

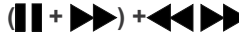
Buttons	DVD Playback	Movie Playback	Picture Playback	Music Playback
	Play	Play	Play	Play
	Pause	Pause	Pause	Pause
	Stop	Stop	Stop	Stop
	Skip backward/ forward	Skip backward/ forward	Rotate	Skip backward/forward
	Highlights a menu item / Shifts the zoomed picture up or down (if available).			
	Rapid advance / Rapid reverse			
<b>GUIDE</b>	Displays time / Views main setup menu			
<b>INFO</b>	Time counter mode selection (during playback). Press repeatedly to switch between modes.			
<b>LANGUAGE</b>	Press <b>Language</b> button to change the audio language.		X	X
<b>MENU</b>	Displays TV menu.			
<b>OK</b>	Enter / View / Play			
<b>GREEN BUTTON</b>	Displays repeat options.			
<b>RETURN/BACK</b>	Returns back to the previous menu (if available).			
<b>YELLOW BUTTON</b>	Goes back to the root folder (if available).			
<b>TEXT</b>	Press <b>Text</b> button to change the subtitle language or turn off the subtitles.		X	X
<b>BLUE BUTTON</b>	Displays disc menu (if available).	Displays disc menu (if available).	X	X
<b>RED BUTTON</b>	Zooms picture. Press repeatedly to switch between zoom options.			

### Other Functions – Button Combinations (During playback)

	Slow forward
	Sets slow forward speed
	Sets rapid advance speed
	Sets rapid reverse speed
	Confirms stop command

(\*) You can switch to title by pressing numeric keys directly. You need to press 0 and then digit key to switch one digit titles (example: to select 5, press 0 and 5).



## Important Instructions

For your own safety read the following instructions carefully before attempting to connect this unit to the mains supply.

### MAINS (AC) OPERATION

The wires in the mains lead are coloured in accordance with the following code :

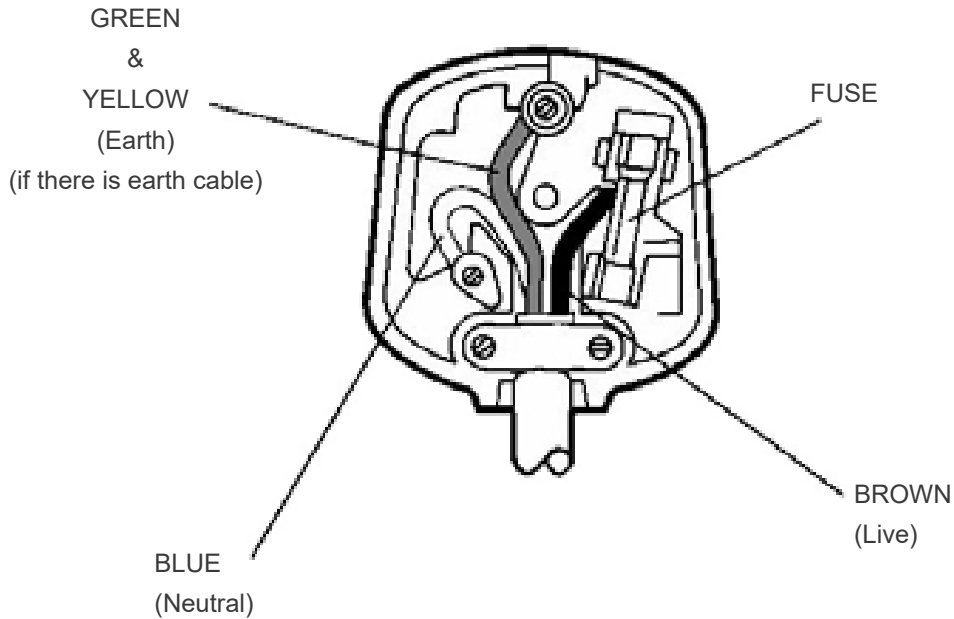

### IMPORTANT

As the colours of the wires in the mains lead of this appliance may not correspond with the coloured markings identifying the terminals in your plug, proceed as follows:

The wire which is coloured green and yellow must be connected to the terminal which is marked with the letter E, or by the earth symbol, or coloured green or green and yellow.

The wire which is coloured blue or black must be connected to the terminal which is marked with the letter N or coloured Black.

The wire which is coloured brown or red must be connected to the terminal which is marked with the letter L or coloured Red.

For continued protection against risk of fire, replace only with same type and rating of fuse (ASTA approved 5A 250VAC fuse).

### CAUTION

TO PREVENT ELECTRIC SHOCK DISCONNECT FROM THE MAINS BEFORE REMOVING COVER. NO USER SERVICEABLE PARTS INSIDE. REFER SERVICING TO QUALIFIED SERVICE PERSONNEL.

### SAFETY PRECAUTION

THIS EQUIPMENT MUST BE DISCONNECTED FROM THE MAINS WHEN NOT IN USE. DO NOT ALLOW THIS UNIT TO BE EXPOSED TO RAIN OR MOISTURE.

VESA WALL MOUNT MEASUREMENTS		
Hole Pattern Sizes (mm)	W	H
	75	75
Screw Sizes		
Length (X)	min. (mm)	5
	max. (mm)	8
Thread (Y)	M4	

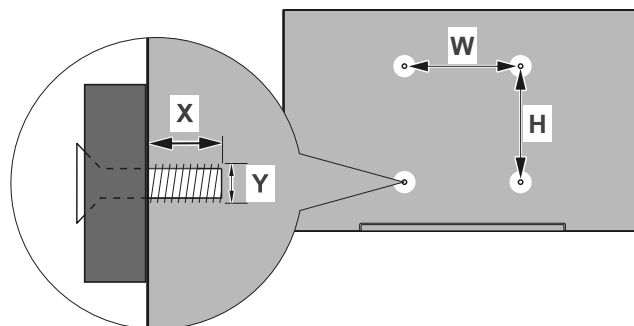

Product Fiche		
Commercial Brand: MITCHELL & BROWN		
Product No.	10127305	
Model No.	JB-24DVD1811	
Energy efficiency class	A+	
Visible screen size (diagonal, approx.) (inch/cm)	24 inches	60 cm
On mode average power consumption (Watt)	19,0	
Annual energy consumption (kWh/annum) (*)	27	
Standby power consumption (Watt)	0,50	
Off mode power consumption (Watt)	N/A	
Display resolution (px)	1366x768	

(\*) Energy consumption kWh per year, based on the power consumption of the television operating 4 hours per day for 365 days. The actual energy consumption will depend on how the television is used.

Hereby, VESTEL Elektronik Sanayi ve Ticaret A.Ş., declares that the radio equipment type TFT IDTV is in compliance with Directive 2014/53/EU. The full text of the EU declaration of conformity is available at the following internet address: [doc.vosshub.com](http://doc.vosshub.com)

## Mitchell & Brown Product Registration

Thank you for purchasing a Mitchell & Brown product.

For Consumers to register your 7 Year warranty visit [www.mitchellandbrown.co.uk](http://www.mitchellandbrown.co.uk)

For any assistance you require with the product please call the Help Line on 01204 377693



CE

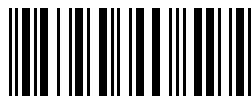

50526668