

MITCHELL & BROWN

OPERATING INSTRUCTIONS



JB-501811F

COLOUR TELEVISION

Contents

Safety Information	2
Markings on the Product.....	2
Environmental Information.....	4
Features	4
Accessories Included.....	4
Standby Notifications.....	4
TV Control Switch & Operation.....	5
Inserting the Batteries into the Remote	5
Connect Power	5
Antenna Connection.....	5
Notification.....	5
Specification	6
Remote Control	7
Connections.....	8
Switching On/Off.....	9
First Time Installation.....	9
Media Playback via USB Input	9
Media Browser Menu.....	9
CEC and CEC RC Passthrough.....	10
TV Menu Contents.....	11
General TV Operation	15
Using the Channel List	15
Configuring Parental Settings.....	15
Electronic Programme Guide (EPG)	15
Teletext Services	16
Software Upgrade.....	16
Troubleshooting & Tips.....	16
PC Input Typical Display Modes.....	17
AV and HDMI Signal Compatibility	17
Supported Video File Formats for USB Mode	18
Supported Picture File Formats for USB Mode	18
Supported Audio File Formats for USB Mode	19
Supported Subtitle File Formats for USB Mode ...	20
Supported DVI Resolutions	21
Important Instructions.....	22

Safety Information

	CAUTION RISK OF ELECTRIC SHOCK DO NOT OPEN	
<p>CAUTION: TO REDUCE THE RISK OF ELECTRIC SHOCK DO NOT REMOVE COVER (OR BACK). NO USER-SERVICEABLE PARTS INSIDE. REFER SERVICING TO QUALIFIED SERVICE PERSONNEL.</p>		

In extreme weather (storms, lightning) and long inactivity periods (going on holiday) disconnect the TV set from the mains.

The mains plug is used to disconnect TV set from the mains and therefore it must remain readily operable. If the TV set is not disconnected electrically from the mains, the device will still draw power for all situations even if the TV is in standby mode or switched off.

Note: Follow the on screen instructions for operating the related features.



IMPORTANT - Please read these instructions fully before installing or operating

WARNING: Never let people (including children) with reduced physical, sensory or mental capabilities or lack of experience and / or knowledge use electrical devices unsupervised.

- Use this TV set at an altitude of less than 2000 meters above the sea level, in dry locations and in regions with moderate or tropical climates.
- The TV set is intended for household and similar general use but may also be used in public places.
- For ventilation purposes, leave at least 5cm of free space around the TV.
- The ventilation should not be impeded by covering or blocking the ventilation openings with items, such as newspapers, table-cloths, curtains, etc.
- The power cord plug should be easily accessible. **Do not** place the TV, furniture, etc. on the power cord. A damaged power cord/plug can cause fire or give you an electric shock. Handle the power cord by the plug, **do not** unplug the TV by pulling the power cord. Never touch the power cord/plug with wet hands as this could cause a short circuit or electric shock. Never make a knot in the power cord or tie it with other cords. When damaged it must be replaced, this should only be done by qualified personnel.
- Do not expose the TV to dripping or splashing of liquids and do not place objects filled with liquids, such as vases, cups, etc. on or over the TV (e.g., on shelves above the unit).
- Do not expose the TV to direct sunlight or do not place open flames such as lit candles on the top of or near the TV.

- Do not place any heat sources such as electric heaters, radiators, etc. near the TV set.
- Do not place the TV on the floor and inclined surfaces.
- To avoid danger of suffocation, keep plastic bags out of the reach of the babies, children and domestic animals.
- Carefully attach the stand to the TV. If the stand is provided with screws, tighten the screws firmly to prevent the TV from tilting. Do not over-tighten the screws and mount the stand rubbers properly.
- Do not dispose of the batteries in fire or with hazardous or flammable materials.

Warning: Batteries must not be exposed to excessive heat such as sunshine, fire or the like.

 Caution	Serious injury or death risk
 Risk of electric shock	Dangerous voltage risk
 Maintenance	Important maintenance component

Markings on the Product

The following symbols are used **on the product** as a marker for restrictions and precautions and safety instructions. Each explanation shall be considered where the product bears related marking only. Note such information for security reasons.

 **Class II Equipment:** This appliance is designed in such a way that it does not require a safety connection to electrical earth.

 **Class II Equipment With Functional Earthing:** This appliance is designed in such a way that it does not require a safety connection to electrical earth, the earth connection is used for functional purposes.

 **Protective Earth Connection:** The marked terminal is intended for connection of the protective earthing conductor associated with the supply wiring.

 **Hazardous Live Terminal:** The marked terminal(s) is/are hazardous live under normal operating conditions.

 **Caution, See Operating Instructions:** The marked area(s) contain(s) user replaceable coin or button cell batteries.

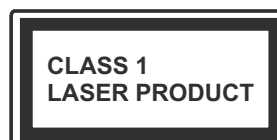

Class 1 Laser Product: This product contains Class 1 laser source that is safe under reasonably foreseeable conditions of operation.

WARNING

Do not ingest the battery, Chemical Burn Hazard

This product or the accessories supplied with the product may contain a coin/button cell battery. If the coin/button cell battery is swallowed, it can cause severe internal burns in just 2 hours and can lead to death.

Keep new and used batteries away from children.

If the battery compartment does not close securely, stop using the product and keep it away from children.

If you think batteries might have been swallowed or placed inside any part of the body, seek immediate medical attention.

WARNING

Never place a television set in unstable or inclined locations. A television set may fall, causing serious personal injury or death. Many injuries, particularly to children, can be avoided by taking simple precautions such as;

- Using cabinets or stands recommended by the manufacturer of the television set.
- Only using furniture that can safely support the television set.
- Ensuring the television set is not overhanging the edge of the supporting furniture.
- Not placing the television set on tall furniture (for example, cupboards or bookcases) without anchoring both the furniture and the television set to a suitable support.
- Not standing the television set on cloth or other materials placed between the television and supporting furniture.
- Educating children about the dangers of climbing on furniture to reach the television set or its controls. If your existing television set is being retained and relocated, the same considerations as above should be applied.

WALL MOUNTING WARNINGS

- Read the instructions before mounting your TV on the wall.
- The wall mount kit is optional. You can obtain from your local dealer, if not supplied with your TV.
- Do not install the TV on a ceiling or on an inclined wall.
- Use the specified wall mounting screws and other accessories.
- Tighten the wall mounting screws firmly to prevent the TV from fall. Do not over-tighten the screws.

WARNING

Apparatus connected to the protective earthing of the building installation through the MAINS connection or through other apparatus with a connection to protective earthing – and to a television distribution system using coaxial cable, may in some circumstances create a fire hazard. Connection to a television distribution system has therefore to be provided through a device providing electrical isolation below a certain frequency range (galvanic isolator, see EN 60728-11)

Environmental Information

This television is designed to be environment friendly. To reduce energy consumption, you can follow these steps:

If you set the **Energy Saving** to **Minimum**, **Medium**, **Maximum** or **Auto** the TV will reduce the energy consumption accordingly. If you like to set the **Backlight** to a fixed value set as **Custom** and adjust the **Backlight** (located under the **Energy Saving** setting) manually using Left or Right buttons on the remote. Set as **Off** to turn this setting off.

Note: Available **Energy Saving** options may differ depending on the selected **Mode** in the **System>Picture** menu.

The **Energy Saving** settings can be found in the **System>Picture** menu. Note that some picture settings will be unavailable to be changed.

If pressed Right button while **Auto** option is selected or Left button while **Custom** option is selected, "**Screen will be off in 15 seconds.**" message will be displayed on the screen. Select **Proceed** and press **OK** to turn the screen off immediately. If you don't press any button, the screen will be off in 15 seconds. Press any button on the remote or on the TV to turn the screen on again.

Note: **Screen Off** option is not available if the Mode is set to **Game**.

When the TV is not in use, please switch off or disconnect the TV from the mains plug. This will also reduce energy consumption.

Features

- Remote controlled colour TV
- Fully integrated digital terrestrial TV (DVB-T-T2)
- HDMI inputs to connect other devices with HDMI sockets
- USB input
- OSD menu system
- Scart socket for external devices (such as DVD Players, PVR, video games, etc.)
- Stereo sound system
- Teletext
- Headphone connection
- Automatic programming system
- Manual tuning
- Automatic power down after up to eight hours.
- Sleep timer
- Child lock
- Automatic sound mute when no transmission.
- NTSC playback
- AVL (Automatic Volume Limiting)
- PLL (Frequency Search)
- PC input
- Game Mode (Optional)
- Ethernet (LAN) for interactive services available on digital channels
- Picture off function

Accessories Included

- Remote Control
- Batteries: 2 x AAA
- Instruction Book
- Quick Start Guide

Standby Notifications

If the TV does not receive any input signal (e.g. from an aerial or HDMI source) for 5 minutes, it will go into standby. When you next switch-on, the following message will be displayed: "**TV switched to stand-by mode automatically because there was no signal for a long time.**" Press **OK** to continue.

If the TV is on and it isn't being operated for a while it will go into standby. When you next switch-on, the following message will be displayed. "**TV switched to stand-by mode automatically because no operation was made for a long time.**" Press **OK** to continue.

TV Control Switch & Operation

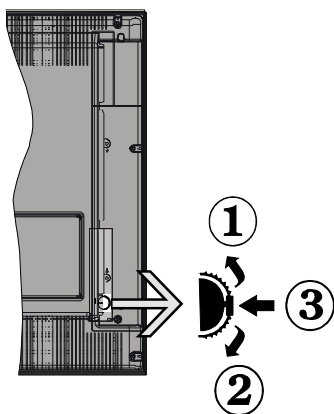

1. Up direction
2. Down direction
3. Volume / Info / Sources List selection and Standby-On switch

The Control button allows you to control the Volume / Programme / Source and Standby-On functions of the TV.

To change volume: Increase the volume by pushing the button up. Decrease the volume by pushing the button down.

To change channel: Press the middle of the button, the information banner will appear on the screen. Scroll through the stored channels by pushing the button up or down.

To change source: Press the middle of the button twice (for the second time in total), the source list will appear on the screen. Scroll through the available sources by pushing the button up or down.

To turn the TV off: Press the middle of the button down and hold it down for a few seconds, the TV will turn into standby mode.

Notes:

- If you turn the TV off, this circle starts again beginning with the volume setting.
- Main menu OSD cannot be displayed via control button.

Operation with the Remote Control

Press the **Menu** button on your remote control to display main menu screen. Use the directional buttons to select a menu tab and press **OK** to enter. Use the directional buttons again to select or set an item. Press **Return/Back** or **Menu** button to quit a menu screen.

Input Selection

Once you have connected external systems to your TV, you can switch to different input sources. Press the **Source** button on your remote control consecutively to select the different sources.

Changing Channels and Volume

You can change the channel and adjust the volume by using the **Volume +/-** and **Programme +/-** buttons on the remote.

Inserting the Batteries into the Remote

Remove the screw that secures the battery compartment cover on the back side of the remote control first. Lift the cover gently. Press and slide the cover to open. Insert two **AAA** batteries. Make sure the (+) and (-) signs match (observe correct polarity). Place the cover back on. Then screw the cover back on again.

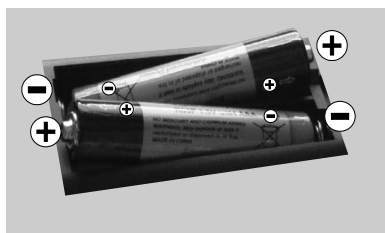

Connect Power

IMPORTANT: The TV set is designed to operate on **220-240V AC, 50 Hz** socket. After unpacking, allow the TV set to reach the ambient room temperature before you connect the set to the mains. Plug the power cable to the mains socket outlet.

Antenna Connection

Connect the aerial plug to the AERIAL INPUT (ANT) socket located on the back of the TV.

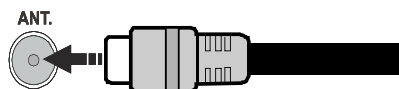

Notification

TRADEMARK ACKNOWLEDGMENT

The terms HDMI and High-Definition Multimedia Interface, and the HDMI Logo are trademarks or registered trademarks of HDMI Licensing LLC in the United States and other countries.



Manufactured under license from Dolby Laboratories. Dolby and the double-D symbol are trademarks of Dolby Laboratories.



Information for Users on Disposal of Old Equipment and Batteries

[European Union only]

Equipment bearing these symbols should not be disposed as general household waste.

You should look for appropriate recycling facilities and systems for the disposal of these products.

Notice: The sign Pb below the symbol for batteries indicates that this battery contains lead.

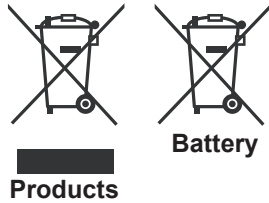

Specification

TV Broadcasting	PAL BG/DK/II' SECAM BG/DK
Receiving Channels	VHF (BAND I/III) - UHF (BAND U) - HYPERBAND
Digital Reception	Fully integrated digital terrestrial TV(DVB-T)
Number of Preset Channels	1.000
Channel Indicator	On Screen Display
RF Aerial Input	75 Ohm (unbalanced)
Operating Voltage	220-240V AC, 50Hz.
Audio	German+Nicam Stereo
Audio Output Power (WRMS.) (10% THD)	2 x 8
Power Consumption (W)	75
TV Dimensions DxLxH (with foot) (mm)	220 x 1134 x 705
TV Dimensions DxLxH (without foot) (mm)	80 x 1134 x 666
Display	50"
Operation temperature and operation humidity	0°C up to 40°C, 85% humidity max

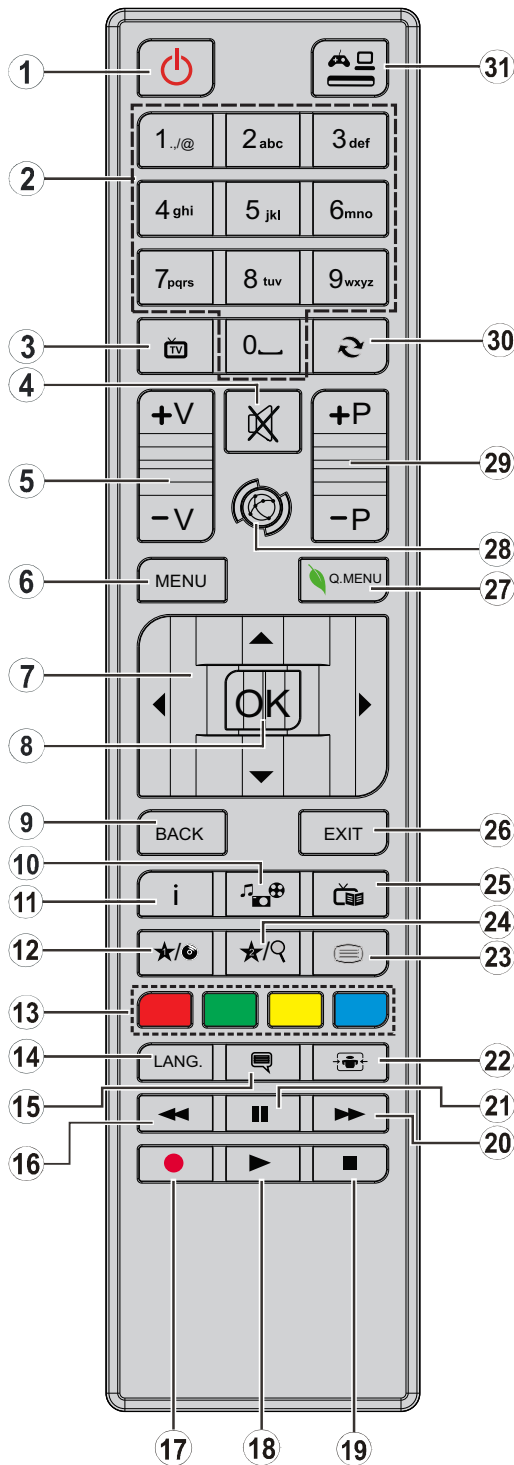













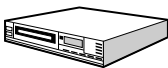
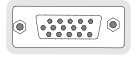

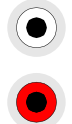



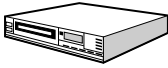









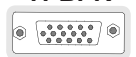

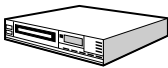
1. **Standby:** Switches On / Off the TV
2. **Numeric buttons:** Switches the channel, enters a number or a letter in the text box on the screen.
3. **TV:** Displays channel list / Switches to TV Source
4. **Mute:** Completely turns off the volume of the TV
5. **Volume +/-**
6. **Menu:** Displays TV menu
7. **Directional buttons:** Helps navigate menus, content etc. and displays the subpages in TXT mode when pressed Right or Left
8. **OK:** Confirms user selections, holds the page (in TXT mode), views channel list (DTV mode)
9. **Back/Return:** Returns to previous screen, opens index page (in TXT mode)
10. **Media browser:** Opens the media browsing screen
11. **Info:** Displays information about on-screen content, shows hidden information (reveal - in TXT mode)
12. **My button 1 (*)**
13. **Coloured Buttons:** Follow the on-screen instructions for coloured button functions
14. **Language:** Switches between sound modes (analogue TV), displays and changes audio/subtitle language (digital TV, where available)
15. **Subtitles:** Turns subtitles on and off (where available)
16. **Rapid reverse:** Moves frames backwards in media such as movies
17. No function
18. **Play:** Starts to play selected media
19. **Stop:** Stops the media being played
20. **Rapid advance:** Moves frames forward in media such as movies
21. **Pause:** Pauses the media being played
22. **Screen:** Changes the aspect ratio of the screen
23. **Text:** Displays teletext (where available), press again to superimpose the teletext over a normal broadcast picture (mix)
24. **My button 2 (*)**
25. **EPG (Electronic programme guide):** Displays the electronic programme guide
26. **Exit:** Closes and exits from displayed menus or returns to previous screen
27. **Quick Menu:** Displays a list of menus for quick access
28. No function
29. **Programme +/-**
30. **Swap:** Quickly cycles between previous and current channels or sources
31. **Source:** Shows all available broadcast and content sources

(*) MY BUTTON 1 & MY BUTTON 2:

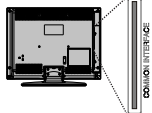
These buttons may have default functions depending on the model. However you can set a special function to these buttons by pressing on them for five seconds when on a desired source or channel. A confirmation message will be displayed on the screen. Now the selected MY BUTTON is associated with the selected function.

Note that if you perform **First Time Installation**, MY BUTTON 1&2 will return to their default function.

Connections

Connector	Type	Cables	Device
	Scart Connection (back)		
	VGA Connection (back)		
SIDE AV 	PC/Y PbPr Audio Connection (side)	 YPbPr/PC Audio Cable (not supplied)	
	HDMI Connection (back)		
SPDIF 	SPDIF (Optical Out) Connection (back)		
SIDE AV 	Side AV (Audio/Video) Connection (side)	 AV Cable (not supplied)	
HEADPHONE 	Headphone Connection (side)		
YPBPR 	YPbPr Video Connection (back)	 PC to YPbPr Connection Cable (not supplied)	
USB 	USB Connection (side)		
 COMMON INTERFACE	CI Connection (side)		
LAN 	Ethernet Connection (back)	 LAN / Ethernet Cable	

 **NOTE:** When connecting a device via the YPbPr or Side AV input, you must use the connection cables to enable connection. See the illustrations on the left side. | You can use YPbPr to VGA cable (not supplied) to enable YPbPr signal via VGA input. | You cannot use VGA and YPbPr at the same time. | To enable PC/YPbPr audio, you will need to use the side audio inputs with a YPbPr/PC audio cable (not supplied) for audio connection. | If an external device is connected via the SCART socket, the TV will automatically switch to AV mode. | When receiving DTV channels (Mpeg4 H.264) or while in Media Browser mode, output will not be available via the scart socket. | When using the wall mounting kit (available from third party in the market, if not supplied), we recommend that you plug all your cables into the back of the TV before mounting on the wall. | Insert or remove the CI module only when the TV is SWITCHED OFF. You should refer to the module instruction manual for details of the settings. The USB input of your TV supports devices up to 500mA. Connecting devices that have current value above 500mA may damage your TV. | By connecting an HDMI cable to your TV, you have to use only a shielded HDMI cable to guarantee a sufficient immunity against parasitic frequency radiation.



If you want to connect a device to the TV, make sure that both the TV and the device are turned off before making any connection. After the connection is done, you can turn on the units and use them.

Switching On/Off

To Switch the TV On

Connect the power cord to a power source such as a wall socket (220-240V AC, 50 Hz).

To switch on the TV from standby mode either:

- Press the “” button, **Programme +/-** or a numeric button on the remote control.
- Press the side function switch on the TV until the TV comes on from standby.

To Switch the TV Off

Press the “” button on the remote control or press the side function switch on the TV until the TV switches into standby mode.

To power down the TV completely, unplug the power cord from the mains socket.

Note: When the TV is switched into standby mode, the standby LED can blink to indicate that features such as Standby Search, Over Air Download or Timer is active. The LED can also blink when you switch on the TV from standby mode.

First Time Installation

When turned on for the first time, the language selection screen is displayed. Select the desired language and press **OK**.

On the next screen, set your preferences using the directional buttons.

Note: Depending on the Country selection you may be asked to set and confirm a PIN at this point. The selected PIN cannot be 0000. You have to enter it if you are asked to enter a PIN for any menu operation later.

About Selecting Broadcast Type

Digital Aerial: If **Aerial** broadcast search option is turned on, the TV will search for digital terrestrial broadcasts after other initial settings are completed.

You can activate **Store Mode** option at this point. This option will configure your TV's settings for store environment and depending on the TV model being used, the supported features of it may be displayed on the top of the screen as an info banner. This option is intended only for store use. It is recommended to select **Home Mode** for home use. This option will be available in **System>Options>More** menu and can be turned off/on later.

Press **OK** button on the remote control to continue. After the initial settings are completed TV will start to search for available broadcasts of the selected broadcast types.

After all the available stations are stored, scan results will be displayed. Press **OK** to continue. The **Edit Channel List** menu will be displayed next. You can edit the channel list according to your preferences or press the **Menu** button to quit and watch TV.

While the search continues a message may appear, asking whether you want to sort channels according to the LCN(*). Select **Yes** and press **OK** to confirm.

(* *LCN is the Logical Channel Number system that organizes available broadcasts in accordance with a recognizable channel number sequence (if available).*

Note: Do not turn off the TV while initializing first time installation. Note that, some options may not be available depending on the country selection.

Media Playback via USB Input

You can connect 2.5" and 3.5" inch (hdd with external power supply) external hard disk drives or USB memory stick to your TV by using the USB inputs of the TV.

IMPORTANT! Back up the files on your storage devices before connecting them to the TV. Manufacturer will not be responsible for any file damage or data loss. Certain types of USB devices (e.g. MP3 Players) or USB hard disk drives/memory sticks may not be compatible with this TV. The TV supports FAT32 and NTFS disk formatting.

Wait a little while before each plugging and unplugging as the player may still be reading files. Failure to do so may cause physical damage to the USB player and the USB device itself. Do not pull out your drive while playing a file.





You can use USB hubs with your TV's USB inputs. External power supplied USB hubs are recommended in such a case.

It is recommended to use the TV's USB input(s) directly, if you are going to connect a USB hard disk.

*Note: When viewing image files the **Media Browser** menu can only display 1000 image files stored on the connected USB device.*

Media Browser Menu

You can play photo, music and movie files stored on a USB disk by connecting it to your TV. Connect a USB disk to one of the USB inputs located on the side of the TV. Pressing the **Menu** button while in the **Media Browser** mode will access the **Picture**, **Sound** and **Settings** menu options. Pressing the **Menu** button again will exit from this screen. You can set your **Media Browser** preferences by using the **Settings** menu.

Loop/Shuffle Mode Operation	
Start playback with the Play button and activate 	All files in the list will be continuously played in original order
Start playback with the OK button and activate 	The same file will be played continuously (repeat)
Start playback with the Play button and activate 	All files in the list will be played once in random order
Start playback with the Play button and activate 	All files in the list will be continuously played in the same random order.

CEC and CEC RC Passthrough

This function allows to control the CEC-enabled devices, that are connected through HDMI ports by using the remote control of the TV.

The **CEC** option in the **System>Settings>More** menu should be set as **Enabled** at first. Press the **Source** button and select the HDMI input of the connected CEC device from the **Sources List** menu. When new CEC source device is connected, it will be listed in source menu with its own name instead of the connected HDMI ports name(such as DVD Player, Recorder 1 etc.).

The TV remote is automatically able to perform the main functions after the connected HDMI source has been selected.

To terminate this operation and control the TV via the remote again, press **Quick Menu** button on the remote, highlight the **CEC RC Passthrough** and set as **Off** by pressing Left or Right button. This feature can also be enabled or disabled under the **System>Settings>More** menu.

The TV supports also ARC(Audio Return Channel) feature. This feature is an audio link meant to replace other cables between the TV and the audio system (A/V receiver or speaker system).

When ARC is active, TV does not mute its other audio outputs automatically. So you need to decrease TV volume to zero manually, if you want to hear audio from connected audio device only (same as other optical or co-axial digital audio outputs). If you want to change connected device's volume level, you should select that device from the source list. In that case volume control keys are directed to connected audio device.

Note: ARC is supported only via the HDMI1 input.

System Audio Control

Allows an Audio Amplifier/Receiver to be used with the TV. The volume can be controlled using the remote control of the TV. To activate this feature set the **Speakers** option in the **System>Settings>More** menu as **Amplifier**. The TV speakers will be muted and the sound of the watched source will be provided from the connected sound system.

*Note: The audio device should support System Audio Control feature and **CEC** option should be set as **Enabled**.*

TV Menu Contents

System - Picture Menu Contents	
Mode	You can change the picture mode to suit your preference or requirements. Picture mode can be set to one of these options: Cinema, Game, Sports, Dynamic and Natural .
Contrast	Adjusts the light and dark values on the screen.
Brightness	Adjusts the brightness values on the screen.
Sharpness	Sets the sharpness value for the objects displayed on the screen.
Colour	Sets the colour value, adjusting the colours.
Energy Saving	For setting the Energy Saving to Custom, Off, Minimum, Medium, Maximum, Auto, Screen off . <i>Note: Available options may differ depending on the selected Mode.</i>
Backlight	This setting controls the backlight level. The backlight function will be inactive if the Energy Saving is set to an option other than Custom .
Advanced Settings	
Dynamic Contrast	You can change the dynamic contrast ratio to desired value.
Noise Reduction	If the signal is weak and the picture is noisy, use the Noise Reduction setting to reduce the amount of noise.
Colour Temp	Sets the desired colour temperature value. Cool, Normal, Warm and Custom options are available.
White Point	If the Colour Temp option is set as Custom , this setting will be available. Increase the 'warmth' or 'coolness' of the picture by pressing Left or Right buttons.
Picture Zoom	Sets the desired image size format.
Film Mode	Films are recorded at a different number of frames per second to normal television programmes. Turn this feature on when you are watching films to see the fast motion scenes clearly.
Skin Tone	Skin tone can be changed between -5 and 5.
Colour Shift	Adjust the desired colour tone.
HDMI Full Range	While watching from a HDMI source, this feature will be visible. You can use this feature to enhance blackness in the picture.
PC Position	
Autoposition	Automatically optimizes the display. Press OK to optimize.
H Position	This item shifts the image horizontally to the right hand side or left hand side of the screen.
V Position	This item shifts the image vertically towards the top or bottom of the screen.
Dot Clock	Dot Clock adjustments correct the interference that appear as vertical banding in dot intensive presentations like spreadsheets or paragraphs or text in smaller fonts.
Phase	Depending on the input source(computer etc.) you may see a hazy or noisy picture on the screen. You can use phase to get a clearer picture by trial and error.
Reset	Resets the picture settings to factory default settings (except Game mode).
<i>While in VGA (PC) mode, some items in Picture menu will be unavailable. Instead, VGA mode settings will be added to the Picture Settings while in PC mode.</i>	

System - Sound Menu Contents	
Volume	Adjusts the volume level.
Equalizer	Selects the equalizer mode. Custom settings can be made only when in User mode.
Balance	Adjusts whether the sound comes from the left or right speaker.
Headphone	Sets headphone volume. Please ensure before using headphones that the headphone volume is set to a low level, to prevent damage to your hearing.
Sound Mode	You can select a sound mode (If the viewed channel supports).
AVL (Automatic Volume Limiting)	Sets the sound to obtain fixed output level between programmes.
Headphone/Lineout	When you connect an external amplifier to your TV using the headphone jack, you can select this option as Lineout . If you have connected headphones to the TV, set this option as Headphone . Please ensure before using headphones that this menu item is set to Headphone . If it is set to Lineout , the output from the headphone socket will be set to maximum which could damage your hearing.
Dynamic Bass	Enables or disables the Dynamic Bass.
Surround sound	Surround sound mode can be changed as On or Off .
Digital Out	Sets digital out audio type.

System - Settings Menu Contents	
Conditional Access	Controls conditional access modules when available.
Language	You may set a different language depending on the broadcaster and the country.
Parental	Enter correct password to change parental settings. You can easily adjust Menu Lock, Maturity Lock, Child Lock or Guidance in this menu. You can also set a new PIN or change the Default CICAM PIN using the related options. <i>Note: Some menu options may not be available depending on the country selection in the First Time Installation. Default PIN can be set to 0000 or 1234. If you have defined the PIN(is requested depending on the country selection) during the First Time Installation use the PIN that you have defined.</i>
Timers	Sets sleep timer to turn off the TV after a certain time. Sets timers for selected programmes.
Date/Time	Sets date and time.
Sources	Enables or disables selected source options.
Network/Internet Settings	Displays network/internet settings.
Accessibility	Displays accessibility options of the TV.
Hard of Hearing	Enables any special feature sent from the broadcaster.
Audio Description	A narration track will be played for the blind or visually impaired audience. Press OK to see all available Audio Description menu options. This feature is available only if the broadcaster supports it.
More	Displays other setting options of the TV.
Menu Timeout	Changes timeout duration for menu screens.
Software Upgrade	Ensures that your TV has the latest firmware. Press OK to see the menu options.
Application Version	Displays current software version.
Subtitle Mode	This option is used to select which subtitle mode will be on the screen (DVB subtitle / Teletext subtitle) if both is available. Default value is DVB subtitle . This feature is available only for the country option of Norway.
Auto TV OFF	Sets the desired time for the TV to automatically go into standby mode when not being operated.
Store Mode	Select this mode for store display purposes. Whilst Store Mode is enabled, some items in the TV menu may not be available.
Power Up Mode	This setting configures the power up mode preference. Last State and Standby options are available.
CEC	With this setting you can enable and disable CEC functionality completely. Press Left or Right button to enable or disable the feature.
CEC Auto Power On	This function allows the connected HDMI-CEC compatible device to turn on the TV and switch to its input source automatically. Press Left or Right button to enable or disable the feature.
Speakers	To hear the TV audio from the connected compatible audio device set as Amplifier . You can use the remote control of the TV to control the volume of the audio device.

Installation Menu Contents	
Automatic channel scan (Retune)	Displays automatic tuning options. Digital Aerial: Searches and stores aerial DVB stations.
Manual channel scan	This feature can be used for direct broadcast entry.
Network channel scan	Searches for the linked channels in the broadcast system. Digital Aerial: Searches for aerial network channels.
First time installation	Deletes all stored channels and settings, resets TV to factory settings.

General TV Operation

Using the Channel List

The TV sorts all stored stations in the **Channel List**. You can edit this channel list, set favourites or set active stations to be listed by using the **Channel List** options. Press the **OK/TV** button to open the **Channel List**. You can filter the listed channels by pressing the **Blue** button or open the **Edit Channel List** menu by pressing the **Green** button in order to make advanced changes in the current list.

Managing the Favourite Lists

You can create four different lists of your favourite channels. Enter the **Channel List** in the main menu or press the **Green** button while the **Channel List** is displayed on the screen in order to open the **Edit Channel List** menu. Select the desired channel on the list. You can make multiple choices by pressing the **Yellow** button. Then press the **OK** button to open the **Channel Edit Options** menu and select **Add/Remove Favourites** option. Press the **OK** button again. Set the desired list option to **On**. The selected channel/s will be added to the list. In order to remove a channel or channels from a favourite list follow the same steps and set the desired list option to **Off**.

You can use the **Filter** function in the **Edit Channel List** menu to filter the channels in the **Channel list** permanently according to your preferences. Using this **Filter** option, you can set one of your four favourite lists to be displayed everytime the **Channel list** is opened. The filtering function in the **Channel list** menu will only filter the currently displayed **Channel list** in order to find a channel and tune in to it. This changes will not remain the next time the **Channel list** is opened.

Configuring Parental Settings

The **Parental Settings** menu options can be used to prohibit users from viewing of certain programmes, channels and using of menus. These settings are located in the **System>Settings>Parental** menu.

To display parental lock menu options, a PIN number should be entered. After coding the correct PIN number, **Parental Settings** menu will be displayed.

Menu Lock: This setting enables or disables access to all menus or installation menus of the TV.

Guidance: This setting enables or disables access some of the MHEG applications. Disabled applications can be released by entering the right PIN.

Set PIN: Defines a new PIN number.

Default CICAM PIN: This option will appear as greyed out if no CI module is inserted into the CI slot of the TV. You can change the default PIN of the CI CAM using this option.

Note: Default PIN can be set to **0000** or **1234**. If you have defined the PIN(is requested depending on the country

selection) during the **First Time Installation** use the PIN that you have defined.

Some options may not be available depending on the country selection in the **First Time Installation**.

Electronic Programme Guide (EPG)

Some channels send information about their broadcast schedules. Press the **EPG** button to view the **Programme Guide** menu.

There are 3 different types of schedule layouts available, **Timeline Schedule**, **List Schedule** and **Now/Next Schedule**. To switch between them follow the instructions on the bottom of the screen.

Timeline Schedule

Zoom (Yellow button): Press the **Yellow** button to see events in a wider time interval.

Filter (Blue button): Views filtering options.

Select Genre (Subtitles button): Displays **Select Genre** menu. Using this feature, you can search the programme guide database in accordance with the genre. Info available in the programme guide will be searched and results matching your criteria will be highlighted.

Options (OK button): Displays event options.

Event Details (Info button): Displays detailed information about selected events.

Next/Prev Day (Programme +/- buttons): Displays the events of previous or next day.

Search (Text button): Displays **Guide Search** menu.

Now (Swap button): Displays current event of the highlighted channel.

List Schedule(*)

(*) In this layout option, only the events of the highlighted channel will be listed.

Prev. Time Slice (Red button): Displays the events of previous time slice.

Next/Prev Day (Programme +/- buttons): Displays the events of previous or next day.

Event Details (Info button): Displays detailed information about selected events.

Filter (Text button): Views filtering options.

Next Time Slice (Green button): Displays the events of next time slice.

Options (OK button): Displays event options.

Now/Next Schedule

Navigate (Directional buttons): Press the **Directional buttons** to navigate through the channels and events.

Options (OK button): Displays event options.

Event Details (Info button): Displays detailed information about selected events.

Filter (Blue button): Views filtering options.

Event Options

Use the directional buttons to highlight an event and press **OK** button to display **Event Options** menu. The following options are available.

Select Channel: Using this option, you can switch to the selected channel.

Set Timer on Event / Delete Timer on Event: After you have selected an event in the EPG menu, press the **OK** button. Select **Set Timer on Event** option and press the **OK** button. You can set a timer for future events. To cancel an already set timer, highlight that event and press the **OK** button. Then select **Delete Timer on Event** option. The timer will be cancelled.

Notes: You cannot switch to any other channel or source while there is an active timer on the current channel.

It is not possible to set timer for two or more individual events at the same time interval.

Teletext Services

Press the **Text** button to enter. Press again to activate mix mode, which allows you to see the teletext page and the TV broadcast at the same time. Press once more to exit. If available, sections in the teletext pages will become colour-coded and can be selected by pressing the coloured buttons. Follow the instructions displayed on the screen.

Digital Teletext

Press the **Text** button to view digital teletext information. Operate it with the coloured buttons, cursor buttons and the **OK** button. The operation method may differ depending on the contents of the digital teletext. Follow the instructions displayed on the digital teletext screen. When the **Text** button is pressed again, the TV returns to television broadcast.

Software Upgrade

Your TV is capable of finding and updating the firmware automatically via the broadcast signal.

Software upgrade search via user interface

On the main menu select **System>Settings** and then **More**. Navigate to **Software upgrade** and press the **OK** button. In **Upgrade options** menu select **Scan for upgrade** and press **OK** button to check for a new software upgrade.

If a new upgrade is found, it starts to download the upgrade. After the download is completed confirm the question asking about rebooting the TV by pressing the **OK** to continue with the reboot operation.

3 AM search and upgrade mode

Your TV will search for new upgrades at 3:00 o'clock if **Automatic scanning** option in the **Upgrade options** menu is set to **Enabled** and if the TV is connected to an aerial signal. If a new software is found and downloaded successfully, it will be installed at the next power on.

Note: Do not unplug the power cord while led is blinking during the reboot process. If the TV fails to come on after the upgrade, unplug, wait for two minutes then plug it back in.

Troubleshooting & Tips

TV will not turn on

Make sure the power cord is plugged in securely to wall outlet. Check if batteries are exhausted. Press the Power button on the TV.

Poor picture

- Check if you have selected the correct TV system.
- Low signal level can cause picture distortion. Please check antenna access.
- Check if you have entered the correct channel frequency if you have done manual tuning.
- The picture quality may degrade when two devices are connected to the TV at the same time. In such a case, disconnect one of the devices.

No picture

- This means your TV is not receiving any transmission. Make sure the correct source has been selected.
- Is the antenna connected properly?
- Is the antenna cable damaged?
- Are suitable plugs used to connect the antenna?
- If you are in doubt, consult your dealer.

No sound

- Check if the TV is muted. Press the **Mute** button or increase the volume to check.
- Sound may be coming from only one speaker. Check the balance settings from **Sound** menu.

Remote control - no operation

- The batteries may be exhausted. Replace the batteries.

Input sources - can not be selected

- If you cannot select an input source, it is possible that no device is connected. If not;
- Check the AV cables and connections if you are trying to switch to the input source dedicated to the connected device.

PC Input Typical Display Modes

The following table is an illustration of some of the typical video display modes. Your TV may not support all resolutions.

Index	Resolution	Frequency
1	640x350	85Hz
2	640x400	70Hz
3	640x480	60Hz
4	640x480	66Hz
5	640x480	72Hz
6	640x480	75Hz
7	640x480	85Hz
8	800x600	56Hz
9	800x600	60Hz
10	800x600	70Hz
11	800x600	72Hz
12	800x600	75Hz
13	800x600	85Hz
14	832x624	75Hz
15	1024x768	60Hz
16	1024x768	66Hz
17	1024x768	70Hz
18	1024x768	72Hz
19	1024x768	75Hz
20	1024x768	85Hz
21	1152x864	60Hz
22	1152x864	70Hz
23	1152x864	75Hz
24	1152x864	85Hz
25	1152x870	75Hz
26	1280x768	60Hz
27	1360x768	60Hz
28	1280x768	75Hz
29	1280x768	85Hz
30	1280x960	60Hz
31	1280x960	75Hz
32	1280x960	85Hz
33	1280x1024	60Hz
34	1280x1024	75Hz
35	1280x1024	85Hz
36	1400x1050	60Hz
37	1400x1050	75Hz
38	1400x1050	85Hz
39	1440x900	60Hz
40	1440x900	75Hz
41	1600x1200	60Hz
42	1680x1050	60Hz
43	1920x1080	60Hz
44	1920x1200	60Hz

AV and HDMI Signal Compatibility

Source	Supported Signals	Available	
EXT (SCART)	PAL	O	
	SECAM	O	
	NTSC4.43	O	
	NTSC3.58	O	
	RGB 50/60	O	
Side AV	PAL	O	
	SECAM	O	
	NTSC4.43	O	
	NTSC3.58	O	
YPbPr	480i, 480p	60Hz	O
	576i, 576p	50Hz	O
	720p	50Hz,60Hz	O
	1080i	50Hz,60Hz	O
HDMI	480i, 480p	60Hz	O
	576i, 576p	50Hz	O
	720p	50Hz,60Hz	O
	1080i	50Hz,60Hz	O
	1080p	24Hz, 25Hz, 30Hz, 50Hz, 60Hz	O

(X: Not Available, O: Available)

In some cases a signal on the TV may not be displayed properly. The problem may be an inconsistency with standards from the source equipment (DVD, Set-top box, etc.). If you do experience such a problem please contact your dealer and also the manufacturer of the source equipment.

Supported Video File Formats for USB Mode

Extension	Video Codec	SPEC (Resolution) & Bit Rate
.dat, vob	MPEG1/2	1080P@30fps - 40 Mbps
.mpg, .mpeg	MPEG1/2, MPEG4	
.ts, .trp, .tp	MPEG1/2, H.264, AVS, MVC	H.264: 1080Px2@30fps - 62.5 Mbps, 1080P@60fps - 62.5 Mbps MVC: 1080P@30fps - 62.5 Mbps Other: 1080P@30fps - 40Mbps
.mp4, .mov, .3gpp, .3gp	MPEG1/2, MPEG4, H.263, H.264, Motion JPEG	H.264: 1080Px2@30fps - 62.5 Mbps, 1080P@60fps - 62.5 Mbps Motion JPEG: 640x480@30fps - 10 Mbps Other: 1080P@30fps - 40 Mbps
.avi	MPEG1/2, MPEG4, Sorenson H.263, H.263, H.264, WMV3, Motion JPEG	
.mkv	MPEG1/2, MPEG4, H.263, H.264, WMV3, Motion JPEG	
.asf	Sorenson H.263, H.264, WMV3, Motion JPEG	
.flv	WMV3	
.swf	RV30/RV40	1080P@30fps - 40 Mbps
.wmv		

Supported Picture File Formats for USB Mode

Image	Photo	Resolution (width x height)	Remark
JPEG	Base-line	15360x8640	The limitation of max resolution depends on DRAM size
	Progressive	1024x768	
PNG	non-interlace	9600x6400	
	interlace	1200x800	
BMP		9600x6400	

Supported Audio File Formats for USB Mode

Extension	Audio Codec	Bit Rate	Sample rate
.mp3,	MPEG1/2 Layer1	32Kbps ~ 448Kbps	16KHz ~ 48KHz
	MPEG1/2 Layer2	8Kbps ~ 384Kbps	
	MPEG1/2 Layer3	8Kbps ~ 320Kbps	
.avi	MPEG1/2 Layer1	32Kbps ~ 448Kbps	16KHz ~ 48KHz
	MPEG1/2 Layer2	8Kbps ~ 384Kbps	
	MPEG1/2 Layer3	8Kbps ~ 320Kbps	
	AC3	32Kbps ~ 640Kbps	32KHz, 44.1KHz, 48KHz
	AAC, HEAAC		8KHz ~ 48KHz
	WMA	128bps ~ 320Kbps	8KHz ~ 48KHz
	WMA 10 Pro M0	< 192kbps	48KHz
	WMA 10 Pro M1	< 384kbps	48KHz
	WMA 10 Pro M2	< 768kbps	96KHz
	LPCM	64Kbps ~ 1.5Mbps	8KHz ~ 48KHz
	IMA-ADPCM, MS-ADPCM	384Kbps	8KHz ~ 48KHz
G711 A/mu-law	64Kbps ~ 128Kbps	8KHz	
.asf	MPEG1/2 Layer1	32Kbps ~ 448Kbps	16KHz ~ 48KHz
	MPEG1/2 Layer2	8Kbps ~ 384Kbps	
	MPEG1/2 Layer3	8Kbps ~ 320Kbps	
	WMA	128bps ~ 320Kbps	8KHz ~ 48KHz
	WMA 10 Pro M0	< 192kbps	48KHz
	WMA 10 Pro M1	< 384kbps	48KHz
	WMA 10 Pro M2	< 768kbps	96KHz
.mkv, .mka	MPEG1/2 Layer1	32Kbps ~ 448Kbps	16KHz ~ 48KHz
	MPEG1/2 Layer2	8Kbps ~ 384Kbps	
	MPEG1/2 Layer3	8Kbps ~ 320Kbps	
	AC3	32Kbps ~ 640Kbps	32KHz, 44.1KHz, 48KHz
	AAC, HEAAC		8KHz ~ 48KHz
	WMA	128bps ~ 320Kbps	8KHz ~ 48KHz
	WMA 10 Pro M0	< 192kbps	48KHz
	WMA 10 Pro M1	< 384kbps	48KHz
	WMA 10 Pro M2	< 768kbps	96KHz
	VORBIS		Up to 48KHz
	LPCM	64Kbps ~ 1.5Mbps	8KHz ~ 48KHz
	IMA-ADPCM, MS-ADPCM	384Kbps	8KHz ~ 48KHz
	G711 A/mu-law	64Kbps ~ 128Kbps	8KHz
	FLAC	< 1.6Mbps	8KHz ~ 96KHz
.ts, .trp, .tp, .dat, .vob, .mpg, .mpeg	MPEG1/2 Layer1	32Kbps ~ 448Kbps	16KHz ~ 48KHz
	MPEG1/2 Layer2	8Kbps ~ 384Kbps	
	MPEG1/2 Layer3	8Kbps ~ 320Kbps	
	AC3	32Kbps ~ 640Kbps	32KHz, 44.1KHz, 48KHz
	EAC3	32Kbps ~ 6Mbps	32KHz, 44.1KHz, 48KHz
	AAC, HEAAC		8KHz ~ 48KHz
	LPCM	64Kbps ~ 1.5Mbps	8KHz ~ 48KHz

Extension	Audio Codec	Bit Rate	Sample rate
.wav	MPEG1/2 Layer1	32Kbps ~ 448Kbps	16KHz ~ 48KHz
	MPEG1/2 Layer2	8Kbps ~ 384Kbps	
	MPEG1/2 Layer3	8Kbps ~ 320Kbps	
	LPCM	64Kbps ~ 1.5Mbps	8KHz ~ 48KHz
	IMA-ADPCM, MS-ADPCM	384Kbps	8KHz ~ 48KHz
	G711 A/mu-law	64Kbps ~ 128Kbps	8KHz
.3gpp, .3gp, .mp4, .mov, .m4a	MPEG1/2 Layer3	8Kbps ~ 320Kbps	16KHz ~ 48KHz
	AC3	32Kbps ~ 640Kbps	32KHz, 44.1KHz, 48KHz
	EAC3	32Kbps ~ 6Mbps	32KHz, 44.1KHz, 48KHz
	AAC, HEAAC		8KHz ~ 48KHz
	VORBIS		Up to 48KHz
	LPCM	64Kbps ~ 1.5Mbps	8KHz ~ 48KHz
	IMA-ADPCM, MS-ADPCM	384Kbps	8KHz ~ 48KHz
.flv	G711 A/mu-law	64Kbps ~ 128Kbps	8KHz
	MPEG1/2 Layer3	8Kbps ~ 320Kbps	16KHz ~ 48KHz
.ac3	AAC, HEAAC		8KHz ~ 48KHz
	AC3	32Kbps ~ 640Kbps	32KHz, 44.1KHz, 48KHz
.swf	AAC, HEAAC		8KHz ~ 48KHz
.ec3	MPEG1/2 Layer3	8Kbps ~ 320Kbps	16KHz ~ 48KHz
.rm, .rmvb, .ra	EAC3	32Kbps ~ 6Mbps	32KHz, 44.1KHz, 48KHz
	AAC, HEAAC		8KHz ~ 48KHz
.wma, .wmv	LBR (cook)	6Kbps ~ 128Kbps	8KHz, 11.025KHz, 22.05KHz, 44.1KHz
	WMA	128bps ~ 320Kbps	8KHz ~ 48KHz
	WMA 10 Pro M0	< 192kbps	48KHz
	WMA 10 Pro M1	< 384kbps	48KHz
.webm	WMA 10 Pro M2	< 768kbps	96KHz
	VORBIS		Up to 48KHz

Supported Subtitle File Formats for USB Mode

Internal Subtitles		
Extension	Container	Subtitle Code
dat, mpg, mpeg, vob	MPG, MPEG	DVD Subtitle
ts, trp, tp	TS	DVB Subtitle
mp4	MP4	DVD Subtitle UTF-8 Plain Text
mkv	MKV	ASS SSA UTF-8 Plain Text VobSub DVD Subtitle

External Subtitles		
Extension	Subtitle Parser	Remark
.srt	Subrip	
.ssa/ .ass	SubStation Alpha	
.smi	SAMI	
.sub	SubViewer MicroDVD DVDSubtitleSystem SubIdx (VobSub)	SubViewer 1.0 & 2.0 Only
.txt	TMPlayer	

Supported DVI Resolutions

When connecting devices to your TV's connectors by using DVI converter cable(DVI to HDMI cable - not supplied), you can refer to the following resolution information.

	56Hz	60Hz	66Hz	70Hz	72Hz	75Hz
640x400				<input checked="" type="checkbox"/>		
640x480		<input checked="" type="checkbox"/>	<input checked="" type="checkbox"/>		<input checked="" type="checkbox"/>	<input checked="" type="checkbox"/>
800x600	<input checked="" type="checkbox"/>	<input checked="" type="checkbox"/>		<input checked="" type="checkbox"/>	<input checked="" type="checkbox"/>	<input checked="" type="checkbox"/>
832x624						<input checked="" type="checkbox"/>
1024x768		<input checked="" type="checkbox"/>	<input checked="" type="checkbox"/>	<input checked="" type="checkbox"/>	<input checked="" type="checkbox"/>	<input checked="" type="checkbox"/>
1152x864		<input checked="" type="checkbox"/>		<input checked="" type="checkbox"/>		<input checked="" type="checkbox"/>
1152x870						<input checked="" type="checkbox"/>
1280x768		<input checked="" type="checkbox"/>				<input checked="" type="checkbox"/>
1360x768		<input checked="" type="checkbox"/>				
1280x960		<input checked="" type="checkbox"/>				<input checked="" type="checkbox"/>
1280x1024		<input checked="" type="checkbox"/>				<input checked="" type="checkbox"/>
1400x1050		<input checked="" type="checkbox"/>				<input checked="" type="checkbox"/>
1440x900		<input checked="" type="checkbox"/>				<input checked="" type="checkbox"/>
1600x1200		<input checked="" type="checkbox"/>				
1680x1050		<input checked="" type="checkbox"/>				
1920x1080		<input checked="" type="checkbox"/>				

Important Instructions

For your own safety read the following instructions carefully before attempting to connect this unit to the mains supply.

MAINS (AC) OPERATION

The wires in the mains lead are coloured in accordance with the following code :

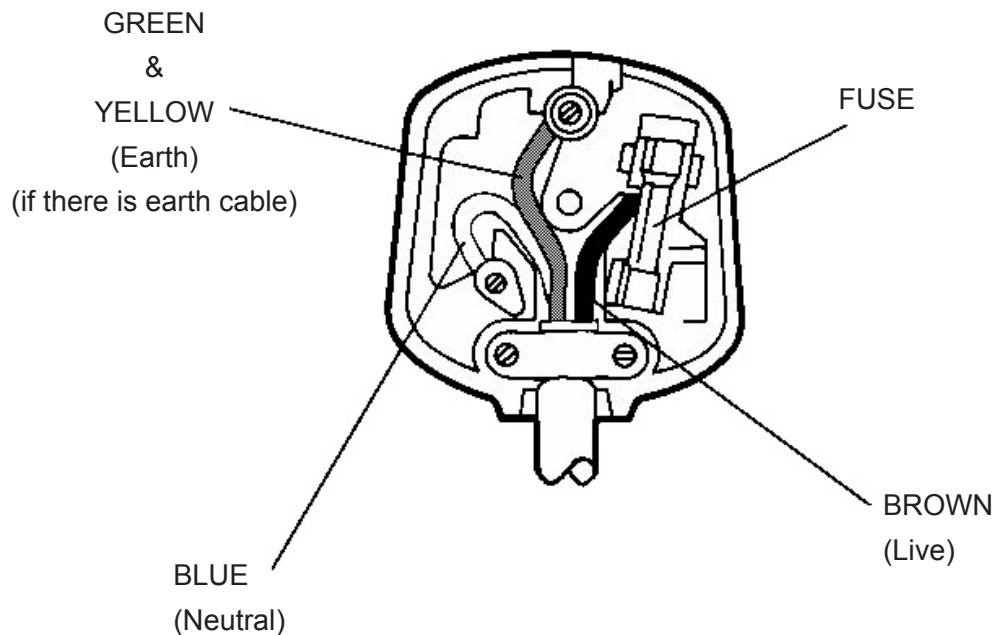

IMPORTANT

As the colours of the wires in the mains lead of this appliance may not correspond with the coloured markings identifying the terminals in your plug, proceed as follows:

The wire which is coloured green and yellow must be connected to the terminal which is marked with the letter E, or by the earth symbol, or coloured green or green and yellow.

The wire which is coloured blue or black must be connected to the terminal which is marked with the letter N or coloured Black.

The wire which is coloured brown or red must be connected to the terminal which is marked with the letter L or coloured Red.

For continued protection against risk of fire, replace only with same type and rating of fuse (ASTA approved 5A 250VAC fuse).

CAUTION

TO PREVENT ELECTRIC SHOCK DISCONNECT FROM THE MAINS BEFORE REMOVING COVER. NO USER SERVICEABLE PARTS INSIDE. REFER SERVICING TO QUALIFIED SERVICE PERSONNEL.

SAFETY PRECAUTION

THIS EQUIPMENT MUST BE DISCONNECTED FROM THE MAINS WHEN NOT IN USE. DO NOT ALLOW THIS UNIT TO BE EXPOSED TO RAIN OR MOISTURE.

Mitchell & Brown Product Registration

Thank you for purchasing a Mitchell & Brown product.

Your Mitchell & Brown product is backed by a full 7 year guarantee from the date of purchase. **(DVD Mechanism in DVD Combination product 1 Year only)** In the unlikely event of anything going wrong, you can have confidence that your purchase is protected.

Warranty registration is easy and secure and once completed you will receive the following benefits and more:

- *Cover in the event of mechanical failure for 7 years from the purchase date*
- *Exclusive information on new products, special offers and promotions*
- *Helpful emails on how to make the most of your product*
- *A more efficient warranty service*

Register your warranty at www.mitchellandbrown.co.uk **This must be registered within 28 days**

VESA WALL MOUNT MEASUREMENTS		
Hole Pattern Sizes (mm)	W	H
	200	200
Screw Sizes		
Length (X)	min. (mm)	10
	max. (mm)	13
Thread (Y)	M6	

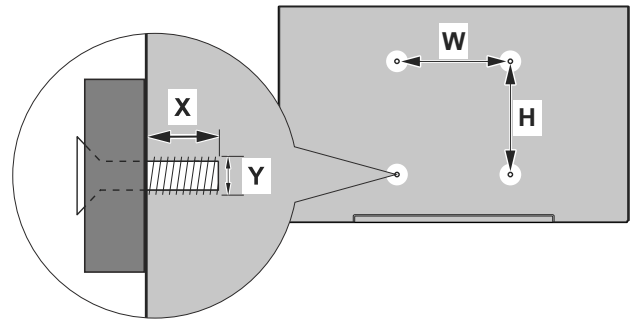

Product Fiche		
Commercial Brand: MITCHELL & BROWN		
Product No.	10106869	
Model No.	JB-501811F	
Energy efficiency class	A+	
Visible screen size (diagonal, approx.) (inch/cm)	50 inches	127 cm
On mode average power consumption (Watt)	71	
Annual energy consumption (kWh/annum)	103	
Standby power consumption (Watt)	0,5	
Off mode power consumption (Watt)	0	
Display resolution (px)	1920x1080	

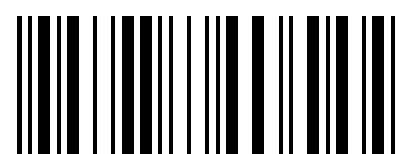

50370098